

Operating Instructions

DE-3000 Series Configurable Safety Shutdown and Control System

with Graphing Capabilities

Form DE-3000 OI 5-20

NEW FEATURES FOR 2019 OR LATER:

- Greatly Expanded Modbus Register List
- 3-Tier Hourmeter

altronic
HOERBIGER Engine Division



TABLE OF CONTENTS *(Click on a section to go to that section)*

- 1.0 OVERVIEW
- 2.0 DISPLAY MODULE
- 3.0 POWER SUPPLY MODULE
- 4.0 TERMINAL MODULE
- 5.0 MOUNTING
- 6.0 WIRING
- 7.0 HAZARDOUS AREA OPERATION
- 8.0 KEYPAD DESCRIPTION
- 9.0 UNDERSTANDING THE HOME SCREENS
- 10.0 VIEW PROCESS INFORMATION SCREENS
- 11.0 VIEW CHANNEL STATUS SCREENS
- 12.0 SHUTDOWN OR FAULT STATUS SCREENS
- 13.0 TEST MODE SCREENS
- 14.0 COOL-DOWN SCREEN
- 15.0 VIEWING/EDITING CONFIGURATION USING THE MENU MODE
- 16.0 VIEWING THE TIME AND DATE OF FIRST FAULT
- 17.0 CONTRAST RATIO ADJUSTMENT (CLASSIC DISPLAY ONLY)
- 18.0 DATA LOGGING AND COMMUNICATION OPTIONS
- 19.0 AUTOMATIC CALL OUT USING AN EXTERNAL MODEM
- 20.0 ALARM FUNCTION
- 21.0 INTEGRATED TIMER OUTPUTS
- 22.0 TROUBLESHOOTING
- 23.0 AUTO START OPTION
- 24.0 OEM ENGINE CONTROL
- 25.0 SELECTING A CONTROL STRATEGY
- 26.0 CALIBRATION OF TRANSDUCERS
- 27.0 PASSWORD PROTECTION
- 28.0 USB VIRTUAL COM PORT DRIVER INSTALLATION
- 29.0 USB VIRTUAL COM PORT DRIVER UNINSTALLATION
- 30.0 PROGRAMMING INSTRUCTIONS

WARNING: DEVIATION FROM THESE INSTRUCTIONS MAY LEAD TO IMPROPER ENGINE OPERATION WHICH COULD CAUSE PERSONAL INJURY TO OPERATORS OR OTHER NEARBY PERSONNEL.

NOTE: IF POSSIBLE, KEEP THE ORIGINAL SHIPPING CONTAINER. IF FUTURE TRANSPORTATION OR STORAGE OF THE CONTROLLER IS NECESSARY, THIS CONTAINER WILL PROVIDE THE OPTIMUM PROTECTION.

WARNING: THE CONTROLLER SYSTEM MUST BE CONFIGURED PRIOR TO USE ON A COMPRESSOR SYSTEM. REFERENCE THE PROGRAMMING INSTRUCTIONS (SECTION 30.0) FOR INSTRUCTIONS DESCRIBING HOW TO CONFIGURE THE CONTROLLER FOR THE SPECIFIC APPLICATION. VERIFY THE PROGRAM IN NONVOLATILE MEMORY (THE EEPROM) PRIOR TO STARTING THE SYSTEM. REFER TO SECTION 10.0 ON HOW TO VIEW THE CURRENT CONFIGURATION.

1.0 OVERVIEW

- 1.1 A glossary of technical terms begins on page 61.
- 1.2 The Altronic DE-3000 controller system is an electronic, microprocessor-based system designed to sense various analog and digital input points to control and monitor industrial compressors. The system is field-programmable using a PC and the supplied terminal program and contains a non-volatile memory to store the setup. Serial communications provide an interface to PC's, PLC's, modems and satellite uplinks for remote communication. An LCD display shows system status, programmed engine/motor and compressor parameters and channel labels. A front-mounted keypad serves as the user interface. The DE-3000 provides for both the safety shutdown functions needed to prevent unnecessary damage to remotely-operated equipment and the closed-loop automatic control functions needed to optimize their efficiency of operation. The DE-3000 also provides for remote data acquisition and supervisory control in a compact, low cost package for industrial compressor applications. The optimization strategies available for the management of compressor throughput include automatic prime mover speed setting as well as capacity control. On rotary screw compressors, capacity control can be done via suction throttling, or using an internal gas bypass technique employing poppet valves, turn valves or slide valves. On reciprocating compressors, capacity can be controlled using external gas bypass loops or pressure regulation techniques. A wide range of output options, including both analog current loops and digital outputs, are provided to interface with the large variety of actuation systems currently in use. In addition, automatic load limiting based upon prime mover power capabilities or other application specific limitations, such as cooling capacity, are readily implemented. There are also AUTO START and OEM ENGINE CONTROL options that are enabled using the terminal program.
- 1.3 The system has three main parts: a panel-mounted Display Module (DE-3000), a Power Supply Module (691122-1), and a Terminal Module (691171-1). These components are interconnected by means of Cable assembly (693115-1). An additional terminal board may be added for 30 extra channels (691171-2) or 15 extra channels (691175-2). This increases the channel selections from 1-30 to 1-60 or 1-45 respectively.

2.0 DISPLAY MODULE

- 2.1 The Display Module serves as the user interface for the DE-3000 system. It is in a 6.5" x 6.5" panel-mounted enclosure and consists of an alphanumeric backlit LCD display, a 16-key front-mounted keypad, DB-25 D-Sub and DB-9 D-Sub connectors and five pairs of serial port indicators.

Two DE-3000 models are available and their displays are compatible with each other, although they have a few functional differences. The 'classic' display is 4x20 characters, and the "new" display features 128x64 multi-color graphics. The larger display uses the top line to further announce the engine status "RUNNING, TIMERS ACTIVE, FIRST FAULT," etc. The home screen, typical of the 4x20 display, appears at the bottom of the larger display. It also incorporates a graphing capability which replaces the original bargraph feature. Color backlighting has been added to the new display. The backlight color changes, e.g., green for RUNNING, yellow for TIMERS ACTIVE and red for STOP/FAULT condition, to indicate the status of the machine.

- 2.2 The keypad is a sealed membrane unit that contains the familiar STOP, RESET and TEST keys as well as other keys used to navigate through channel status and description, view process screens, and to edit the configuration.
- 2.3 The LCD displays a HOME SCREEN that displays a status line, the speed, the suction pressure and the discharge pressure. Pressing the VIEW CHANNEL key displays the channel number, its timer status, analog value (if applicable) and the corresponding 20-character user defined label.

CLASSIC DISPLAY



NEW DISPLAY



- 2.4 The keypad, along with the LCD display, are used to navigate through channel status and descriptions, view process screens, and to view or edit the system's configuration. The ↑UNITS or ↓UNITS or the →TENS or ←TENS keys are used to access channels by increasing or decreasing the channel numbers by one or by ten with each key press. Pressing the NEXT key advances the display to the next screen or item. All menu adjustments are saved in non-volatile EEPROM memory by pressing the ENTER key. The EEPROM memory retains the current configuration during normal operation, after compressor shutdown and a system power-down.
- 2.5 Five pairs of LED's are provided on the back of the Display Module for troubleshooting purposes, one Receive (RX) and one Transmit (TX) LED for each port. The TX LED will flash when the Display Module is transmitting serial communications on the labeled port. The RX LED will flash when the Display Module is receiving serial communications on the labeled port.
- 2.6 Ports 4 and 5 are located on the display board.

3.0 POWER SUPPLY MODULE

- 3.1 The Power Supply Module is made to be rail-mounted and is the interface between the Terminal and Display Modules and to other systems. It typically plugs directly into the Terminal Module using the DB-25 connectors and is held together with screws and screw locks.
- 3.2 The Power Supply Module accepts up to four industry-standard, commercially-available 0.6 inch plug-in Output Modules. The Output Modules provide a means of using the DE-3000 controller safety shutdown system status to interface with other systems on the engine/motor and compressor. A typical application would be as a relay or solenoid coil driver. The Output Modules are optically isolated, solid-state switches which are isolated from power supply minus and engine ground. The Output Modules will be in the open (de-energized) condition when the unit is not powered.

Outputs 1 and 2 can be software-configured for either normally-open (N/O) or normally-closed (N/C) operation and have an LED indicator associated with them. Outputs 3 and 4 are pre-programmed normally-open for use with the optional OEM Engine Control or Auto start feature. If an Output Module is programmed for normally-closed (energized for run), the LED will be ON in the normal run condition and OFF for a fault condition. For Normally-open configured modules the LED will be OFF for normal run condition and turn ON for a fault condition.

The standard Output Module outputs use the top row of the dual 16-position terminal strip which is marked OUT 1 through OUT 4. Each of these outputs are fused with a replaceable 6.3 amp slow-blow fuse, Altronic P/N 601653. In addition to accepting industry-standard Output Modules, a custom Altronic Output Module P/N 691124 is available for tripping ignition powered CD fuel valves and shorting CD ignition shutdown leads upon a fault. When making use of OEM Engine Control, outputs 1 and 2 will not be wired to trip the fuel and ignition valves. When both functions are required, two of these modules are used as follows: OUT 1 slot must be used to trip the fuel valve, and OUT 2 slot must be used to short the ignition. If 12-24Vdc is lost to the DE-3000 annunciator system, the custom Output Modules will trip the fuel valve and short the ignition shutdown lead. This mimics the "fail-safe" operation of a normally-closed Output Module and therefore the LED will be ON in the normal run condition and OFF for a fault condition. In programming the system, these modules are identified by using the IGN/FUEL selection. Terminals IGN+ and IGN- are used to connect the shutdown lead, and FV1 and FV2 are used for the CD fuel valve. A capacitor is included in the Power Supply Module to supply the energy to trip the fuel valve.

- 3.3 The 12-24Vdc power for the DE-3000 system is applied to the power supply terminals marked (+) and (-) 12-24Vdc INPUT POWER. A 6.3 amp replaceable slow-blow fuse protects the system from over-currents, and a power LED lights when power is applied to the system.

- 3.4 The external connection for the two serial RS-485 communication ports is on the Power Supply Module terminal strips. Port 2 is for RS-485 serial communication to future Altronic instruments, and port 3 is for RS-485 serial communication to a PC (personal computer) or a PLC (programmable logic controller) to perform remote monitoring or control functions if desired.
- 3.5 Terminals marked IGN IN and PU IN are used by the DE-3000 system to detect either engine rotation or ignition system firings. This input monitors changing signals such as those seen on either the ignition shutdown lead or a magnetic pickup monitoring an engine mounted gear.

THE MAGNETIC PICKUP INPUT MUST BE USED FOR APPLICATIONS ENABLING THE AUTO START OR OEM ENGINE CONTROL FUNCTION.

- The IGN IN terminal connects to the positive (+) C.D. ignition shutdown lead.
- The PU IN terminal connects to one magnetic pickup input; the other pickup wire connects to the minus (–) terminal on the Power Supply Module.

NOTE: AN INSTALLATION MAY USE ONLY ONE OF THE TERMINALS IGN IN, PU IN, OR T+.

4.0 TERMINAL MODULE

- 4.1 The Terminal Module is made to be rail-mounted and is the point of interface between the field sensor wiring and the DE-3000 control system. A removable dual terminal strip is used for the connection of the system to the equipment mounted discrete sensors which may consist of up to 30 inputs, where any of the 30 can be used for either a normally-open, normally-closed switch, or analog inputs including K- or J-type thermocouples. These are listed as channels 01–30 for the 691171-1 terminal board. They accept industry-standard transducer signals in the range of 0-5 VDC. Connections from the Terminal Module to the Display Module are made using the 693115-x series Cable Assembly.

691171-1 FOR CHANNELS 01-30

691171-2 FOR CHANNELS 31-60

691175-2 FOR CHANNELS 31-45

- 4.2 The DE-3000 is designed to operate with industry-standard voltage or current-amplified output transducers in the range of 0 to 5Vdc or 0 to 25mA. Four series of transducers are available from Altronic: pressure transducers 691201-x, 691204-x and temperature transducers 691202/203-300, 691212/213-450.

- 4.3 Another terminal board assembly may be added to increase the inputs from 30 to either 45 or 60 inputs. Use cable 693133-1 to connect the two boards. The 691175-2 provides an additional 15 inputs, 4 digital outputs, 2 analog outputs and an extra speed (pickup) input. The 691171-2 provides an additional 30 inputs, 8 digital outputs, 2 analog outputs, and an extra speed (pickup) input.

4.4 PRESSURE TRANSDUCERS

The pressure transducers, Altronic P/N 691201-x and P/N 691204-x, are packaged in a rugged sealed case with a NPT pressure port, a corrosion resistant media cavity, and a Packard Electric Metri-Pack connector. The ranges available are 0-100, 300, 500, 1000, 2000, and 5000 PSIG for the 691201-x series and 0-50,100, 300, 500 PSIA for the 691204-x series, all of which have an overload rating of 1.5 times full scale without damage. The three wires from the transducer are: +5 volt excitation, +0.5 to 4.5 volt output, and minus return. These three wires connect directly to the back of the Terminal Module using cable assembly P/N 693008-x.

4.5 DIFFERENTIAL MEASUREMENTS

Differential pressures or temperatures may be measured by using two consecutive channels. The transducers used to measure differential values must be of the exact same type and range. The first channel of the pair will display the basic parameter it is monitoring and the second channel of the pair will display the numeric difference in engineering units of its value subtracted from the first channel's value. Setpoints for each channel monitor the displayed value of that channel. The second channel setpoints monitor the differential value.

4.6 TEMPERATURE TRANSDUCER

The temperature transducers, Altronic P/N 691202-300, 691203-300 with a temperature measurement range of +5 to 300°F and the 691212-450, 691213-450 with a temperature range of -40 to +450°F are packaged in a sealed, stainless steel

housing with a 5/8"-18 UNF threaded body, and a Packard Electric Metri-Pack connector. During configuration the standard calibration for the 691202/203-300 sensor is selected as dEG1 and the standard calibration for the 691212/213-450 is selected by choosing dEG2. The three wires from the transducer are: +5 volt excitation, temperature output voltage, and minus return. These wires connect directly to the Terminal Module using cable assembly P/N 693008-x.

4.7 THERMOCOUPLE INPUTS

The Terminal Modules can accept industry-standard type J or K thermocouples on inputs O1–60. Automatic cold junction compensation is built-in. The units can be configured to °F or °C. Both a high and low setpoint is associated with each channel. The monitor can read type J thermocouples between -76°F and +1382°F (-60°C and +750°C) and type K thermocouples between -76°F and +1472°F (-60°C and +800°C).

4.8 N/O and N/C INPUTS

The inputs can also accept standard normally-open and normally-closed contacts. For normally-open input, place the wire between the corresponding inputs. Ground the connection to cause a fault. Similarly, for normally-closed, wire the sensor in a normally-closed connection and open it to cause a fault.

4.9 4-20mA inputs

The terminal module can accept 4-20mA inputs by selecting the internally-connected 200-ohm resistors, creating a termination voltage of .8 to 4.0 volts. The jumper wires between the + and – terminals for that channel must be connected for proper operation.

4.10 For each input, the corresponding CHANNEL SWITCH must be set according to the input type. Switches are turned ON by moving them toward the ANALOG OUT labeling.

4.11 Digital outputs 1 through 8 are pilot-duty, and turn on to common ground when closed. Outputs 1 through 8 are rated at 500mA, 60V. See FIG. 8 for wiring details.

5.0 MOUNTING

5.1 DISPLAY MODULE

Mount the Display Module inside a control panel or to a suitable flat surface so that the display is at a convenient viewing height. A drilling template and mounting dimensions are provided.

5.2 POWER SUPPLY MODULE

Mount the Power Supply Module in the panel either on the bottom or the side of the main panel. The Power Supply Module is made to be rail-mounted onto commercially available 32 or 35mm DIN mounting rails. It is also made to plug directly into the Terminal Module using the DB-25 connectors and is held together with screws and screw locks. Two end brackets P/N 604199 should be used to keep the modules from sliding off the ends of the mounting rail.

Alternatively, the Power Supply Module and the Terminal Module can be mounted separate from each other on the DIN mounting rails but in the same panel; in this case, a DB-25 male/female cable such as P/N 693115-1 is used to electrically connect these modules. The operating temperature range of the Power Supply Module is -31°F to +176°F (-35°C to +80°C).

5.3 TERMINAL MODULE

Mount the Terminal Module either on the bottom or the side of the main panel. The Terminal Module and Power Supply Module can be rail-mounted onto commercially available 32 or 35mm DIN mounting rails. The Terminal Module plugs directly into the Power Supply Module using the DB-25 D-Sub connectors and is held together with screws and screw locks. Two end brackets P/N 604199 are used to keep the modules from sliding off the ends of the rail. The Terminal Module and the Display Module are electrically connected with a DB-25 male/female cable, 693115-x series or equivalent. The operating temperature range of the Terminal Module is -31°F to +176°F (-35°C to +80°C).

EACH SET SWITCH MUST BE SET FOR PROPER OPERATION

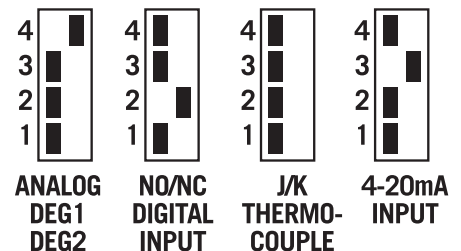

NOTE: AVOID MOUNTING THE UNIT WITH THE LCD DISPLAY FACING DIRECT SUNLIGHT. THE DISPLAY OPERATING TEMPERATURE RANGE IS -13°F TO +149°F (-25°C TO +65°C).

IMPORTANT: PRESSURE TRANSDUCERS WILL WITHSTAND OVERLOADS AS HIGH AS 1.5 TIMES RATED PRESSURE. IF THE OVERLOAD RATING IS EXCEEDED, FAILURE MAY OCCUR. PRESSURE FLUCTUATIONS OCCUR IN MOST RECIPROCATING SYSTEMS; PICK THE TRANSDUCER WITH A RATING HIGH ENOUGH TO PREVENT OVERLOAD BY PEAK PRESSURES OF PULSATIONS. IT IS RECOMMENDED THAT A PRESSURE SNUBBER BE USED WHICH WILL REDUCE THE PEAK PRESSURE APPLIED TO THE TRANSDUCER. THE LIFE OF THE TRANSDUCER WILL BE EXTENDED WITH THE USE OF A SNUBBER OR PULSATION DAMPENER.

5.4 PRESSURE TRANSDUCER

Mount the pressure transducer in the panel or in a manifold or tube off of the engine. Do not expose the pressure transducer to temperatures above 221°F (105°C). The second terminal module should be placed close to the first and the wire connecting them should be free of high-powered panel signals.

5.5 TEMPERATURE TRANSDUCER

Mount the temperature transducer in a thermowell on the engine or machine. The actual sensor is located at the bottom of the transducer body; to ensure accuracy, the tip of the probe should be surrounded by the measured media.

IMPORTANT: DO NOT EXCEED THE ABSOLUTE MAXIMUM RATING OF THE TRANSDUCERS, 350°F (176°C) FOR THE 691202/203-300 OR 450°F (232°C) FOR THE 691212/213-450. CARE SHOULD BE TAKEN TO PROTECT THE WIRING AND CONNECTORS FROM CONTACT WITH HOT SURFACES.

6.0 WIRING (SEE WIRING DIAGRAMS)

6.1 SYSTEM COMPONENT WIRING

A DB-25 male/female cable, 693115-x series or equivalent, is used to connect the Terminal Module to the Display Module and secured with the cable lock screws. If mounted on the same mounting rail, plug the Terminal Module directly into the Power Supply Module using the DB-25 D-Sub connectors at the ends of the modules and secure them together with the screws and screw locks captive to the connectors. If the Power Supply Module and the Terminal Module are mounted separate from each other (must be mounted in the same panel) a DB-25 male/female cable such as P/N 693115-1 or equivalent is used to connect these modules.

6.2 POWER WIRING

Connect the supply power wires to the 12-24Vdc input power terminals on the power supply, plus to terminal (+) and minus to terminal (-); power requirement is 12 to 24Vdc (10 watts max.). The DC- terminal must be connected to panel ground which should be the same as engine ground.

This is the return path for normally-open sensors and **MUST** be connected for proper operation. **DO NOT** ground this device directly to the ignition system common coil ground.

6.3 SENSOR WIRING DISCRETE INPUTS

The sensor leads connect to the removable terminal strips on the Terminal Module. The terminal numbers correspond to the display numbers which also have a user assigned 20-character label associated with it. The sensor inputs are numbered 01-30, 01-45 or 01-60. With AUTO START enabled, the Remote Reset on the terminal board is wired for a start switch. Sensor inputs 01-60 can be configured as class A, class B or class C logic. Any discrete sensor point can be wired for normally-open or normally-closed operation.

- Normally-open (N/O) sensor switches are wired with one wire to the bottom terminal strip of the respective sensor number and the other to engine ground which should be the same as power minus (-). A short jumper from the bottom terminal to the top terminal must be connected for normally-open sensors. (See wiring diagrams)
- Normally-closed (N/C) sensor switches are wired with one wire to the bottom terminal strip and the other to the top terminal strip of the respective sensor number. Note that the short jumper wire must be removed.
- Remote stop and remote reset are wired the same as the sensor switches, and can be used with either normally-open or normally-closed contacts.

Use a wire size between 16 AWG (max.) and 24 AWG (min.) to connect the sensor switches to the terminal strip connector. Strip the insulation back 3/8"; twist the exposed wires tightly together. Insert the exposed wire completely into the terminal strip and securely tighten the clamping screw. Wires running to sensor switches must be in good condition or replaced with new wires. When running wires, take care not to damage the insulation and take precautions against later damage from vibration, abrasion, or liquids in conduits. An explosion-proof conduit is not required. However; wires should be protected from damage by run-

ning them in a protective conduit or in sheaths where appropriate. In addition, it is essential that the following practices be adhered to:

- A. Never run sensor wires in the same conduit with ignition wiring or other high energy wiring such as the AC line power.
- B. Keep secondary wires to spark plugs and other high voltage wiring at least eight inches (200mm) away from sensor and sensor wiring.
- C. Sensor switches may be connected to any passive device using contacts such as standard switch gauges, pressure or level switches. **DO NOT** connect sensor leads to any voltage producing element.
- D. In the case of a field conversion, where sensors have previously been used with Murphy tattletales, it is recommended that the sensors be checked frequently when the DE system is first put into use. Sensor contacts may be burned or pitted from past exposure to ignition system primary voltage. It is advisable to replace such sensors.
- E. If it becomes necessary to check sensor switch to panel wiring with an ohmmeter or other checker, first DISCONNECT the plug-in terminal strips from the Terminal Module. Applying voltage to the DE-3000 system through the sensor leads may damage the device. The area should be tested as non-hazardous before such testing commences.

ANALOG SENSOR WIRING

For each analog monitored point, inputs O1–60, select a transducer - either an Altronic pressure or temperature transducer listed above or one that outputs a signal in the range of 0 to 5 Vdc or 0 to 25 mA. Mount as described above. Use cable assembly 693008-x or similar to wire transducer to the Terminal Module. An internal 5 volt sensor supply (500 mA. max.) is available to power the Altronic transducers; See wiring diagrams. If the 5 volt sensor supply exits the panel, it must be fused with a 0.5 ampere fuse. If 24Vdc powered sensors are used, the 24 volt supply to them must be fused appropriately. Take care not to damage the insulation when installing and take precautions against later damage from vibration, abrasion, or liquids in conduits. In addition, it is essential that the following practices be adhered to:

- A. Never run sensor wires in the same conduit with ignition wiring or other high energy wiring such as AC line power.
- B. Keep secondary wires to spark plugs and other high voltage wiring at least eight inches (200mm) away from sensor and sensor wiring.

6.4 THERMOCOUPLES AND THERMOCOUPLE EXTENSION WIRE

Grounded or ungrounded type J or K thermocouples may be used. Use thermocouple extension wire of the same type as the thermocouple probe to connect to the terminal module. Use stranded thermocouple wire having a moisture-resistant insulation such as PVC; for higher ambient temperatures, Teflon or B-fibre insulated thermocouple wire is recommended. To ensure that an accurate signal is transmitted to the device, avoid any added junctions, splices and contact with other metals. On unused channels, leave the small jumper wire supplied with the system in place. Take care not to damage the insulation when installing and take precautions against later damage from vibration, abrasion, or liquids in conduits. In addition, it is essential that the following practices be adhered to:

- A. Never run sensor wires in the same conduit with ignition wiring or other high energy wiring such as AC line power.
- B. Keep secondary wires to spark plugs and other high voltage wiring at least eight inches (200mm) away from sensor and sensor wiring.

6.5 LUBE/NO-FLOW SENSOR:

Channels 27 and 28 may be used for a lube/no-flow proximity cycle switch as an option. Wire the sensor according to section 6.3. The Sensor may be wired as either a N/O or a N/C with a jumper. The DIP switches on the terminal board

must be set as a discrete input. The lube/no-flow channels generate a fault when the time between pulses exceeds the programmed run pulse time.

NOTE: ADDITIONAL CHANNEL SET UP WILL BE REQUIRED IN THE TERMINAL SOFTWARE PROGRAM.

6.6 OUTPUT SWITCH WIRING

The Power Supply Module accepts an industry-standard 0.6" Output Module. The following modules are available from Altronic:

691124 This custom module has two uses: connection to a Murphy fuel valve and directly grounding a C.D. ignition system.

- A. Use in position OUT 1 to connect to a C.D. ignition-type Murphy fuel valve. Connect terminals 3 and 8 of the fuel valve to the Power Supply Module terminals marked F1 (FV1) and F2 (FV2).
- B. Use in position OUT 2 to directly ground-out (stop) a C.D. ignition system. Wire the C.D. ignition shutdown lead and ignition ground to the Power Supply Module terminals marked I+ (IGN+) and I- (IGN-) observing the proper polarity for the ignition system.
DO NOT connect directly to the ignition system common coil ground.

691125 This module is rated for 5-48 Vdc, 5.0 A. and may be used in any of the four output slots OUT 1 through OUT 4.

This module may be used to interrupt the DC supply to DC-powered ignition systems such as Altronic CD1, CPU-90, II-CPU or DISN.

691056 This module is rated for 5-60 Vdc, 2.0 A. and may be used in any of the four output slots OUT 1 through OUT 4.

691066 This module is rated for 5-200 Vdc, 0.67 A. and may be used in any of the four output slots OUT 1 through OUT 4.

691065 This module is rated for 24-280 Vac, 2.0 A. and may be used in any of the four output slots OUT 1 through OUT 4.

6.7 RS-485 COMMUNICATIONS WIRING

There are four RS-485 communication ports available:

- Port 2 is for communication between the display and terminal boards.
- Port 3 is for RS-485 serial communication to a PC or a PLC.

The wiring for port 3 connects to the terminals marked A3, B3 and S3. Connect to the other communication devices A to A(-) and B to B(+). Connect the shield wire to the DE-3000 system **ONLY**.

6.8 SENSE ROTATION INPUT

Terminals marked IGN IN and PU IN on the Power Supply Module are used by the DE-3000 system to detect either engine rotation or ignition system firings. On applications using multiple terminal board assemblies, the T+ terminal on the second terminal board (the one not directly connected to the power supply) can be used to add a second RPM value. The T+ input is only for use with magnetic pickups. This input monitors voltage signals such as those seen on either the ignition shutdown lead or a magnetic pickup monitoring an engine-mounted gear.

- The IGN IN terminal connects to the positive (+) C.D. ignition shutdown lead.
- The PU IN terminal connects to one magnetic pickup input; the other pickup wire connects to the minus (-) terminal on the Power Supply Module.
- **The T+ terminal connects to one magnetic pickup input; the other pickup wire connects to the $\frac{1}{2}$ terminal on the terminal module.**

NOTE: AN INSTALLATION MAY USE ONLY ONE OF THE TERMINALS IGN IN, PU IN, OR T+.

THE MAGNETIC PICKUP INPUT **MUST** BE USED FOR APPLICATIONS ENABLING THE OPTIONAL AUTO START OR OEM ENGINE CONTROL FUNCTION.

7.0 HAZARDOUS AREA OPERATION

7.1 The DE-3000 system is CSA-certified for CLASS I, DIVISION 2, GROUPS C and D areas when mounted in a suitable enclosure.

In addition, the following requirements must be met (refer to NFPA standard no. 493):

- The low voltage sensor switch wires within the panel enclosure must be kept at least two (2) inches away from other wiring. Run the sensor switch wires leaving the panel in a separate conduit from all other wiring and keep them separate
- Wiring to the sensors must have a grade of insulation capable of withstanding an AC voltage of 500 volts RMS.
- Sensor wires must be run in separate conduits and junction boxes from high voltage wires such as ignition, fuel valve, and other high voltage wiring.

WARNING: SUBSTITUTION OF COMPONENTS MAY IMPAIR INTRINSIC SAFETY AND/OR SUITABILITY FOR CLASS I, DIV. 2, GROUPS C AND D. DO NOT DISCONNECT EQUIPMENT IN DIV. 2 ENVIRONMENT UNLESS POWER IS SWITCHED OFF OR THE AREA IS KNOWN TO BE NON-HAZARDOUS.

8.0 KEYPAD DESCRIPTION

8.1 The DE-3000 controller Display Module contains a sixteen-key sealed membrane keypad which is used to stop, reset and test the system. The user can also view process information screens, view channel specifics, cancel timers, and view and edit pertinent operating parameters.

8.2 STOP key is used for a manual stop condition. By pressing the STOP key, the controller activates the configured output modules in the power supply.

8.3 RESET key clears all past faulted points and resets all input and output timers to their preset values.

8.4 TEST key disables the output modules and allows the user to fault or test the input sensors. Every time the test button is pressed, the test timer resets to its preset value.

8.5 CANCEL TIMERS key cancels all timers.

8.6 VIEW CHAN key allows the user to view the status of any input channel and its user defined label. Pushing the VIEW CHAN key after a fault will display the faulted channel and current value.

8.7 NEXT key allows the user to view the CAPACITY CONTROL and RPM SETPOINT CONTROL screens from the home screen. From the VIEW screen, allows the user to view the next process information screen. From the MENU screens, the next value to be edited.

8.8 VIEW key allows the user to view the status of the digital outputs 1 through 8 following the first depression. If the digital output is on, the number of that output will be viewable. Pressing the VIEW key a second time will open the graphing mode.

8.9 ENTER key is used to accept a selection and to save a new value in memory.

8.10 ESC key enables the user to exit any view channels, information or menu screens at any time and return to the previous screen without changing programmed values.

8.11 MENU key allows the user to enter the edit menu. The global timers, input class output assignment, output configuration and the time and date may be viewed and adjusted using the MENU key.

8.12 ↑UNITS/↓UNITS keys increase or decrease values by one. The →TENS/←TENS keys increase or decrease values by ten. They are used to increase or decrease channel numbers, timers and to move the pointer in the menu screen.

8.13 F1 - Function key displays the analog input and output channels.

8.14 F2 - From the RUNNING home screen; used to initiate the cool-down timer. After a fault, displays the time and date of the 1st fault.

9.0 UNDERSTANDING THE HOME SCREENS

9.1 The home screens are a series of screens used to display several of the most critical operating parameters. All of the home screens provide a status word on the upper line and, typically, the engine speed on the second line, the suction pressure on the third line, and the discharge pressure on the fourth line. Other analog parameters may be programmed for the second, third and fourth lines.

The status line will read one of the following: TIMERS ACTIVE, RUNNING, TEST XXX SEC, FAULT AL12, MANUAL STOP, AUTO START.

The LCD display always reverts to one of the home screens after a keypad operation is completed or the operation times out.

9.2 To manually start the engine, press the RESET button. The TIMERS ACTIVE message will be displayed and remains until all Class B and Class C inputs have been armed. During the time that the Class B and Class C timers are still active, manually purge and crank the engine.

```
TIMERS ACTIVE  
  
STATUS TIMERS ACTIVE  
SPEED      330 RPM  
SUCTION    102.3 PSIA  
DISCHARGE  200 PSIG
```

```
STATUS TIMERS ACTIVE  
SPEED      330 RPM  
SUCTION    102.3 PSIA  
DISCHARGE  200 PSIG
```

9.3 If the AUTO START option is selected when programming the system from the PC, the display below will appear when the AUTO START sequence begins. The auto start sequence allows for activation of an electrically controlled pre-lube pump for a programmed time period prior to cranking. It is recommended that a warning horn or flashing light be activated by the pre-lube output to inform any personnel which may be present that a cranking attempt is about to begin. After this user programmed time delay, cranking will begin. A user-programmable crank disconnect speed switch function will automatically disable the starter at the selected RPM. If the crank disconnect RPM is not reached within a user programmed time period, and Multi-Start has not been enabled, an OVERCRANK FAULT will be generated turning off the fuel and ignition and disabling the starter until a new AUTO START command is received.

```
AUTO START  
  
STATUS AUTO START  
SPEED      130 RPM  
SUCTION    102.3 PSIA  
DISCHARGE  200 PSIG
```

```
STATUS AUTO START  
SPEED      130 RPM  
SUCTION    102.3 PSIA  
DISCHARGE  200 PSIG
```

If Multi-Start has been enabled, the DE-3000 will automatically attempt another AUTO START sequence if the crank disconnect RPM is not met within the user-defined time. Once the AUTO START sequence has failed, a delay timer will begin counting down before the system starts up again. During this delay time, the display will flash red and yellow and state "RESTART PENDING-XXXs", with "XXX" being the time left before restart. Multi-Start can be configured for up to 4 start attempts (or a restart after 3 failed attempts).



WARNING: WHEN PROGRAMMED FOR MULTI-START, THE DE-3000 WILL AUTOMATICALLY ATTEMPT TO START THE ENGINE AS MANY AS FOUR TIMES. RESTARTS ARE MADE BETWEEN 30 AND 90 SECONDS FOLLOWING AN OVERCRANK FAULT. PERSONNEL AROUND THE ENGINE MUST BE NOTIFIED TO TAKE THE NECESSARY SAFETY PRECAUTIONS TO AVOID INJURY OR MALFUNCTION.

- 9.4 If the OEM ENGINE CONTROL option is chosen when programming the DE-3000, the same AUTO START screen shown in section 9.3 will be displayed when the sequence is initiated. OEM engine control signals Driven Equipment Ready (DER), starts the Crank/Multi-Start disconnect timer, and activates a pre-lube pump when the sequence begins. If the Crank/Multi-Start disconnect speed is not met within its allotted time, an OVERCRANK FAULT is issued by the DE. The pre-lube will turn OFF after a programmed disconnect speed is reached. If the pre-lube disconnect speed is not reached in a given amount of time, a PRELUBE FAULT will be generated. The start signal and auxiliary module will turn ON after a specified amount of time. The start signal will remain ON between 1-5 seconds, or during the entire running time of the DE. When a manual stop or fault occurs, the DER signals OFF and the post-lube, start signal (if still ON) and auxiliary module remain ON for an individually programmed amount of time before turning OFF.

If Multi-Start has been enabled, the DE-3000 will automatically attempt another OEM ENGINE CONTROL sequence if the Crank/Multi-Start disconnect RPM is not met within the user-defined time. Just like the Multi-Start for AUTO START, once the sequence has failed, the display will flash a delay timer will begin counting down before the system starts up again. Multi-Start can be configured for up to 4 start attempts (or a restart after 3 failed attempts).

- 9.5 After all Class B and Class C points have timed out and are being monitored, and if no faults are detected, the home screen will show the RUNNING message. This is the screen that will remain under normal operation.

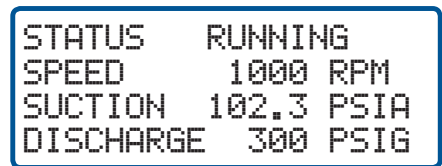

9.6 Whenever a programmed servicemeter interval has expired, a * character will be displayed at the end of the STATUS word on the top line of the HOME screen. Digital control output #7 will turn ON when any service meter interval has expired. This output can be used to trigger a horn or light or to initiate a service call. The servicemeter will show the hours remaining until a scheduled service function is required. When a service function is overdue, the hours left will display 0. To access the servicemeter messages, press the Menu key from the Home screen, and then select Hourmeter Functions.

PRESS TO
VIEW
MESSAGE

F1

RUNNING

HOURLMETER/RESET TIME
MESSAGE NUMBER: >00
TOTAL HOURS: 8971
OPERATING HOURS

STATUS* RUNNING
SPEED 1000 RPM
SUCTION 102.3 PSIA
DISCHARGE 300 PSIG

PRESS TO
CHANGE
NUMBER

↑
UNITS

RUNNING

HOURLMETER/VIEW/CLEAR
MESSAGE NUMBER: +00
TOTAL HOURS: 8971
OPERATING HOURS

HOURLMETER / SERVICE
MESSAGE NUMBER: +00
TOTAL HOURS: 8971
OPERATING HOURS

PRESS TO
CHANGE
NUMBER

↑
UNITS

RUNNING

HOURLMETER/VIEW/CLEAR
MESSAGE NUMBER: +01
HOURS LEFT: 100
OIL CHANGE REQUIRED

HOURLMETER / SERVICE
MESSAGE NUMBER: +01
HOURS LEFT: 100
OIL CHANGE REQUIRED

Proceed through the servicemeter messages to find the required service. The number of hours left until the listed maintenance is due is displayed for each service message. When the hours left reaches zero the * character is displayed on the home screen status line.

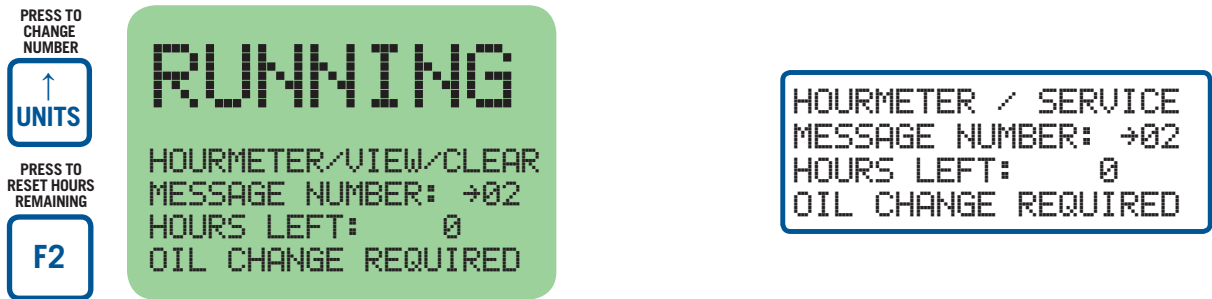

There are up to eleven user programmable service messages. The desired messages and service intervals are selected when programming the DE-3000 system. The service intervals can only be changed by using the terminal program and the PC. The servicemeter alert can be reset after the required service is performed by pressing the F2 key with the desired message displayed. Each servicemeter message is individually reset.

9.7 CONTROL SCREEN

From the home screen, the CONTROL LOOP #1 screen is accessed by pressing the NEXT key once. CONTROL LOOP #1 is a closed loop PID controller which is assigned to the analog value measured by channel 01. This can be virtually any pressure, temperature, valve position or other equipment parameter which can be expressed as an analog value from 0 to 5 volts. Some typical controlled values would be the discharge pressure of a compressor, the intake manifold pressure of an engine, the temperature of a cooling system or the chemical composition of a process output. The first line of the display will indicate the input channel/output channel and the current value of the controlled parameter. The next line shows the desired value, the setpoint, of the controlled parameter. The third line shows the current settings of the loop tuning values; the P: 45% indicates a proportional band setting of 45%, the I:1s indicates an integral term of 1 second, and the D:450m indicates a derivative value of 450 minutes.

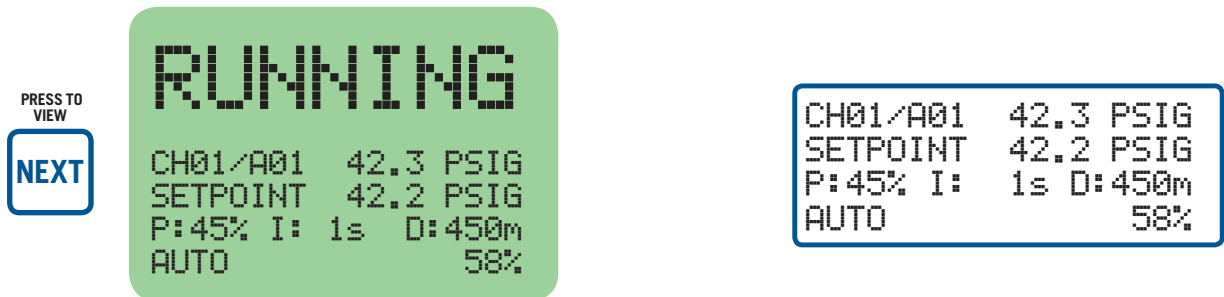

The current values of the control loop can be viewed at any time, however, to change these values, a specific key sequence must be entered first. To unlock the control loop values, enter the password (see section 27.0). A small arrow will appear next to the value to be changed. Use the arrow keys to change the value and the ENTER key to accept the new value. As the ENTER key is pressed, the controller will begin controlling to that value and the cursor advances to the next value. To disable the optional automatic control and force the controller output to a particular value after unlocking the control, press the F1 key. The display will indicate that the unit is in MANUAL and the current value of the output. Use the UNITS arrow keys to change the setpoint value.

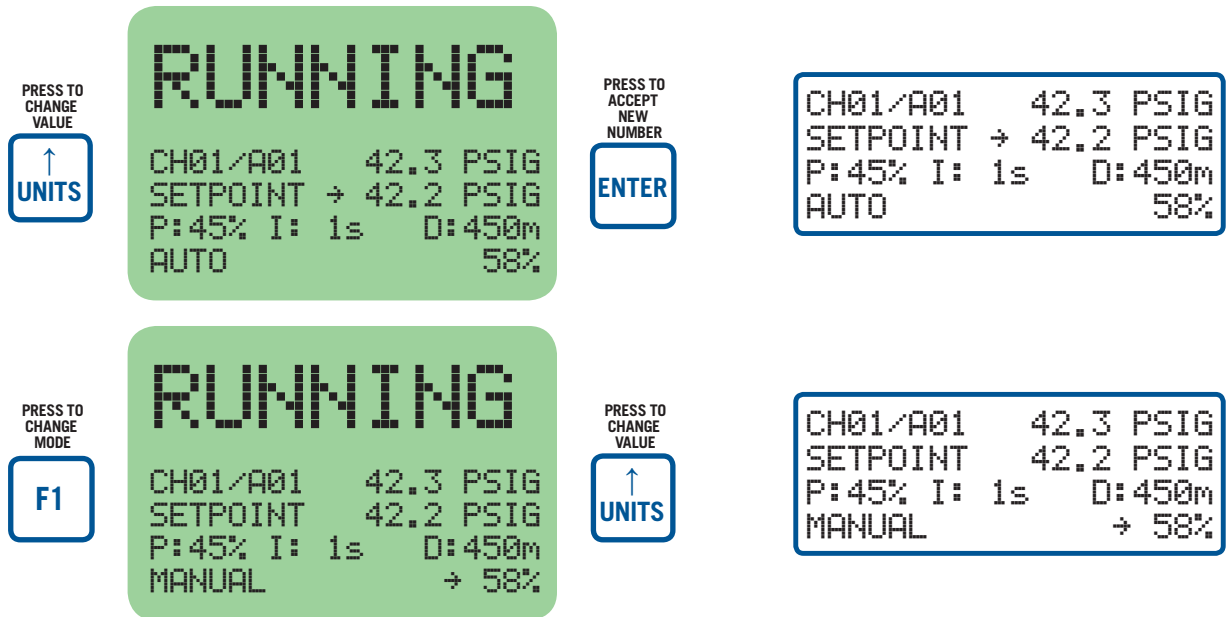

The second control loop, CONTROL LOOP #2, is accessed by pressing the NEXT key twice from the HOME screen. This second loop can be set as a second independent PID loop (like LOOP #1), a CASCADE RPM controller, or a LINEAR/RAMP controller. If used for a second PID loop, the control is based on the analog input of Channel 02. In addition to controlling the 4-20mA output, based upon the channel 02 analog voltage, a closed loop control of the input frequency being measured by the RPM input Channel S01 is also possible. The selection of which channel acts as the control input is made when programming the unit from the PC Terminal program. In order to change the tuning values for LOOP #2 from the LOOP #2 screen, the same key sequence as for LOOP #1 is used.

When CONTROL LOOP #2 is used for CASCADE RPM control or LINEAR/RAMP control, the analog input on Channel 01 is used to drive the output on A02. CASCADE RPM control enables engine speed to be controlled based on the control setpoint on LOOP #1. Once LOOP #1 is forcing a maximum output, engine speed will increase up to a maximum RPM in order to achieve the control setpoint on Channel 01. LINEAR/RAMP control maps Channel 01 setpoints to defined 4-20 mA states (mapped to RPM values) on A02. This can be set up for either direct or inverse acting. LINEAR/RAMP control can be initiated either after a specified warmup time or the time when input on Channel 26 surpasses its low control setpoint.

For a Linear/Ramp Control example, assume the unit is programmed as follows:

- Linear/Ramp Control for suction pressure on Channel 01
- Low setpoint = 5.0 PSIG at 6mA
- High setpoint = 20.0 PSIG at 18mA

This will then create a graph as follows (page 16):

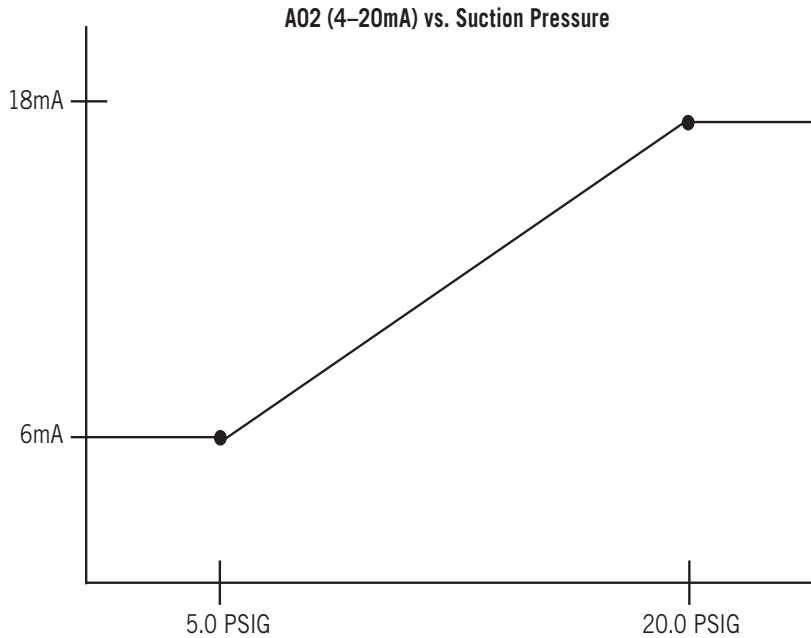

The screens which will appear for LOOP #2, depending upon which program options are used, are shown below.

PRESS TWICE TO VIEW

NEXT

OR

PRESS TWICE TO VIEW

NEXT

OR

PRESS TWICE TO VIEW

NEXT

RUNNING

CH02/A02 42.3 PSIG
 SETPOINT 42.2 PSIG
 P:45% I: 1s D:450m
 AUTO 58%

CH02/A02 42.3 PSIG
 SETPOINT 42.2 PSIG
 P:45% I: 1s D:450m
 AUTO 58%

PRESS TWICE TO VIEW

NEXT

OR

PRESS TWICE TO VIEW

NEXT

RUNNING

CH02/A02 1199 RPM
 SETPOINT 1200 RPM
 P: 45% I: 1s D:450m
 AUTO 58%

CH02/A02 1199 RPM
 SETPOINT 1200 RPM
 P: 45% I: 1s D:450m
 AUTO 58%

PRESS TWICE TO VIEW

NEXT

RUNNING

Calculated 1800 RPM
 A02 54
 Suction 13.3 PSIA
 RPM 1800 RPM

Pressing NEXT again will reveal any further terminal board PID screens following the same protocol for viewing, modifying and saving PID information. For CASCADE RPM control and LINEAR/RAMP control, the control screens allow the user to view the input and output values. In order to change the control strategy for LINEAR/RAMP control, see section 15.6.

- 9.8 In addition to the two 4-20mA analog control loop outputs, the DE-3000 offers a pulsed digital output control option on Digital outputs #1 and #2 for use with solenoid valves or motor valves. This option is referred to as PULSE CONTROL and allows for closed loop control of the variable measured by the analog voltage measured by input channel 03. The pulse control is attached to channel 03, allowing for three independent control loops. When PULSE CONTROL is used, Digital output #1 is used to open a valve or to increase the output when it is ON. Digital output #2 is used to close a valve or decrease the output when it is turned ON. A decision of which output to activate and for how long is made once per cycle. A maximum ON time limit is selected when programming the unit from the PC Terminal Program. To change the control variables for PULSE OUTPUTS, select EDIT CONTROL VALUES from main menu and press the ENTER key. The edit control values menu is shown. Next, select EDIT CONTROLS. From the EDIT CONTROLS screen, select EDIT PRIM. CONTROLS and press the ENTER key.

SCREEN 1: RUNNING
 EDIT SETPOINTS
 →EDIT CONTROLS
 EDIT PID DEADBAND
 CALIBRATION

SCREEN 2: RUNNING
 LINEAR/RAMP CONTROL
 >EDIT PRIM. CONTROLS

SCREEN 3: RUNNING
 CONTROL 35.0 PSIG
 CYCLE TIME → 2 s
 PROP. BAND 40 %
 DEAD BAND 0.5 PSI

NOTE: THE RESET FUNCTION CAN ALSO BE IMPLEMENTED BY USING THE EXTERNAL HARDWARE.RESET/AUTO START INPUT AVAILABLE ON THE TERMINAL MODULE. THE BEHAVIOR OF THE CONTROLLER AND DISPLAY WILL BE DETERMINED BY THE PROGRAMMING SELECTIONS MADE WHEN CONFIGURING THE UNIT.

PARAMETERS:
 CYCLE TIME → 2 s
 PROP. BAND 40 %
 DEAD BAND 0.5 PSI

- 9.9 On some applications, in addition to all of the standard PID control tuning, it may be desirable to allow for a small controller deadband in order to promote system stability. To set or edit the PID deadband value, select this function from the Menu as shown.

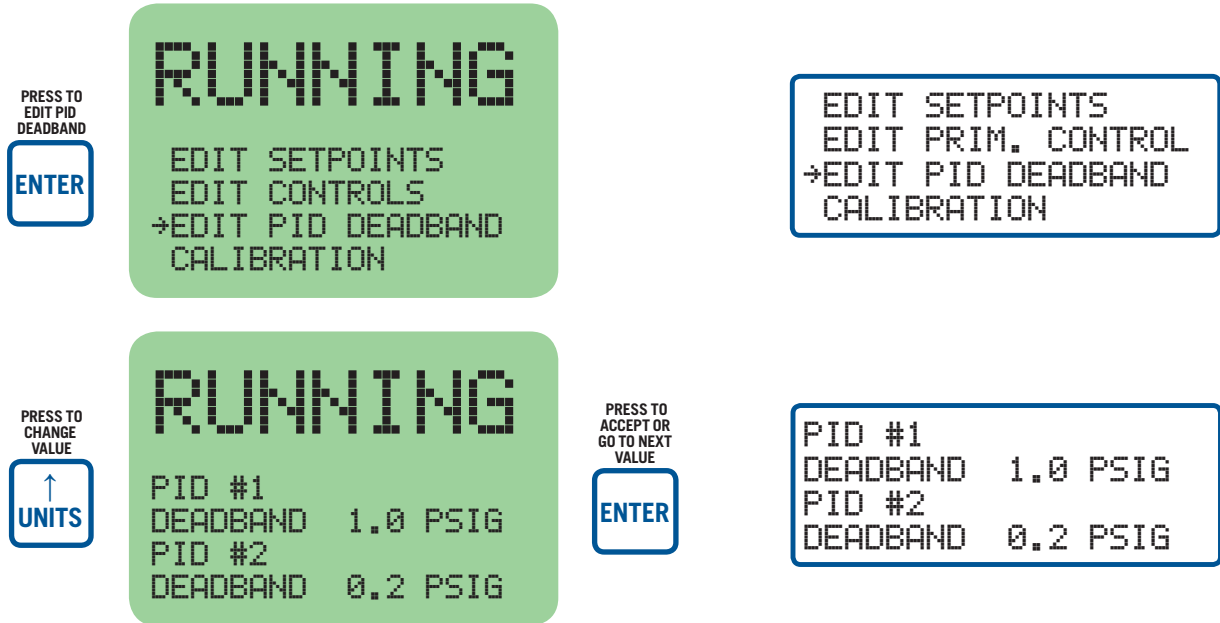

9.10 The TEST home screen is entered by pressing the TEST key. The TEST mode disarms all outputs and may only be entered from the RUNNING mode. The test time remaining is shown on the top line. See section 13.0 TEST MODE SCREENS for more information.



9.11 If a fault condition occurs, the FAULT message for the first faulted channel will appear on the display and will remain there until it is acknowledged. The numbers one through two, after AL (alarm), shows the output switch that is faulted. To view the first fault screen again, press the VIEW CHAN key. If all of the faulted sensors have been cleared and the RESET key is pressed, the class B, C and output timers will reset and the display will return to the TIMERS ACTIVE home screen.

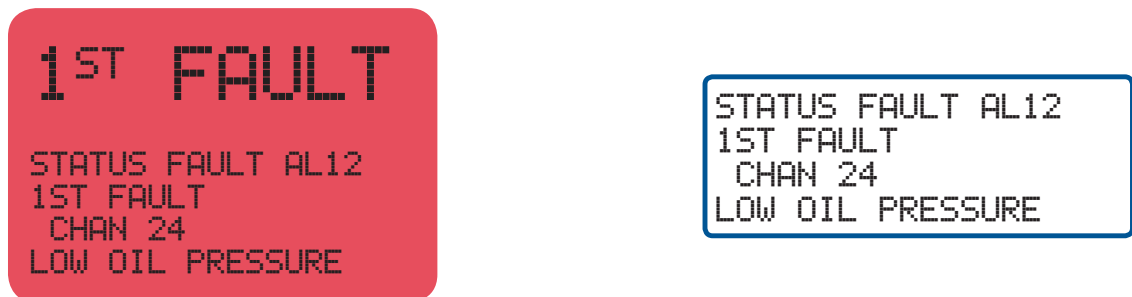

RETURNS TO
FAULT HOME
SCREEN



PRESS TO
RETURN TO
1ST FAULT
SCREEN



PRESS
TO CLEAR
FAULTS,
RESET
TIMERS AND
OUTPUTS

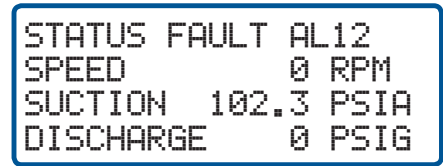
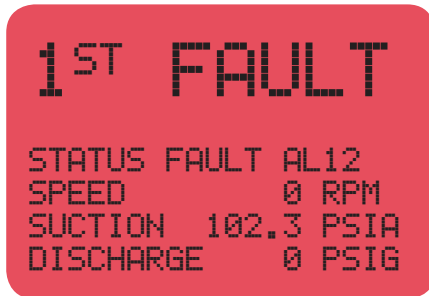

9.12 The MANUAL STOP message will supersede all of the above home screens if the STOP key is pressed.

PRESS TO
STOP

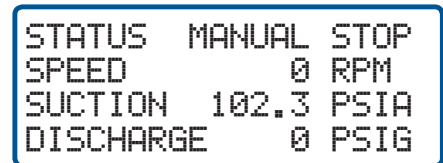

NOTE: THE STOP FUNCTION CAN ALSO BE IMPLEMENTED REMOTELY BY USING THE EXTERNAL STOP INPUT AVAILABLE ON THE TERMINAL MODULE. THE BEHAVIOR OF THE CONTROLLER AND DISPLAY WILL BE IDENTICAL TO THAT OBTAINED BY PRESSING THE LOCAL STOP KEY ON THE DISPLAY MODULE.

10.0 VIEW PROCESS INFORMATION SCREENS

10.1 The VIEW PROCESS screen displays which digital outputs on the terminal board are on/off. It also displays either a bargraph or graphing, depending on the type of display being used.



PRESS

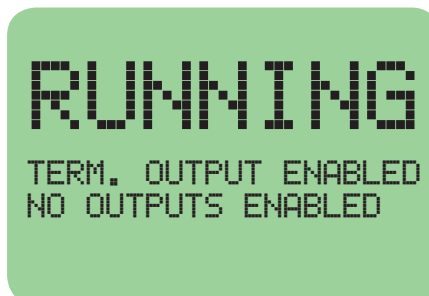

PRESS

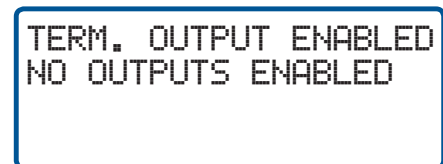

This screen indicates which digital outputs on the terminal board(s) are turned on. In the above example, no outputs are currently turned on.

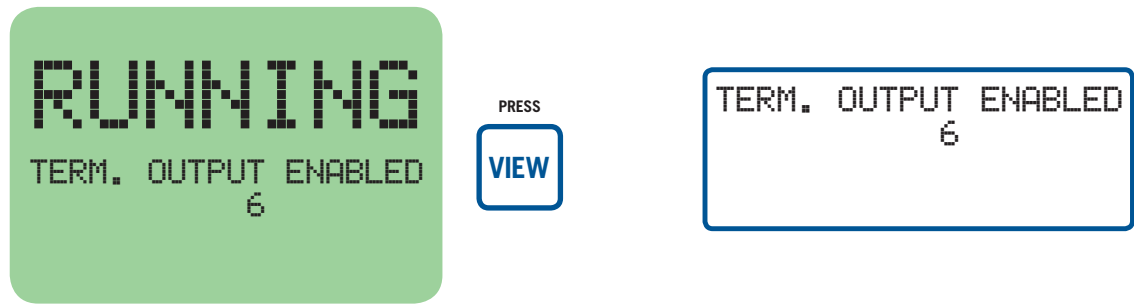

The above example shows digital output #6 on the terminal board is turned on.

10.2 Pressing the VIEW key again presents a different screen depending on which display is being used. The 128x64 multi-color graphics display will show the screen below. The 4x20 display will show the screen(s) at right.



Use the UP and DOWN arrow keys to select which channel to graph. Only the analog input channels may be selected. Press the ENTER key after a selection has been made.

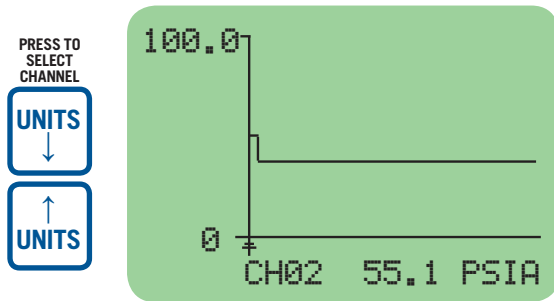

New data is displayed on the left hand side and the oldest data is shown to the right. New data will occur once per minute and makes the displayed information 'move' to the right hand side of the screen. The information is updated once per minute allowing the user to view 90 minutes of past data on the screen.

Use the UP and DOWN arrow keys to graph other analog channels (including speed).

10.3 **CLASSIC DISPLAY ONLY (NOTE: These screens are shown in right margin.)**

The process information screens can be accessed from any of the home screens (except the test home screen) or from the view channel screen by pressing the VIEW key. There are six process screens: one, three and five each display up to four user-programmed process variables; screens two, four and six display an analog bargraph associated with the previous process variable screen. Thus, up to 12 process variables can be displayed both digitally and in bargraph format.

The analog values are monitored by a microprocessor on the terminal board and are configured by using a PC and the terminal program. The bargraph end points are set by the low and high setpoints of the safety shutdown function. Unused channel screens will not be displayed.

NOTE: THE FOLLOWING SCREENS DISPLAY THE FIRST GROUP OF FOUR SELECTED ANALOG INPUTS IN DIGITAL AND BARGRAPH FORM.

PRESS "VIEW" FOR DIGITAL INFORMATION

SUCTION	22 PSIA
DISCHRG	100 PSIG
FILTR	10 PSIA
BOP	110 PSIG

PRESS "VIEW" FOR BARGRAPH SCREEN

SUCTION	L	H
DISCHRG	L	H
FILTR	L	H
BOP	L	H

NOTE: THE FOLLOWING SCREENS DISPLAY THE SECOND GROUP OF FOUR SELECTED ANALOG INPUTS IN DIGITAL AND BARGRAPH FORM.

PRESS "VIEW" FOR DIGITAL INFORMATION

TEMP 1	180 °F
TEMP 2	250 °F
TEMP 3	300 °F
TEMP 4	320 °F

PRESS "VIEW" FOR BARGRAPH SCREEN

TEMP 1	L	H
TEMP 2	L	H
TEMP 3	L	H
TEMP 4	L	H

11.0 VIEW CHANNEL STATUS SCREENS

11.1 Use the VIEW CHAN key to enter the view channels screens. Once in the VIEW CHAN mode, the user can view any channel's details.

- The first line will be the controller system status; TIMERS ACTIVE, RUNNING, FAULT AL12, or MANUAL STOP.
- The second line shows whether the input point is "ARMED" or "NOT ARMED". Class A points will always be armed; class B points become armed only after their timers have timed out. Class C points arm when cleared or when the timer times out.
- The third line shows the channel number and an analog value of that input; if configured for that channel.
- The fourth line shows the user entered 20 character channel description.

Upon pressing the view channel key, channel 01 will be shown. The UNITS and TENS keys allow the user to quickly navigate through the controller channels. Use the ↑ UNITS or ↓ UNITS keys to increase or decrease the viewed channel by one. Use the → TENS or ← TENS keys to increase or decrease the viewed channel by ten. To exit the VIEW CHAN mode, press the ESC key. After five minutes with no keypad activity, the display will revert to the current home screen.

FROM CURRENT HOME SCREEN

PRESS 

TIMERS ACTIVE

STATUS TIMERS ACTIVE
SPEED 330 RPM
SUCTION 102.3 PSIA
DISCHARGE 200 PSIG

STATUS TIMERS ACTIVE
SPEED 330 RPM
SUCTION 102.3 PSIA
DISCHARGE 200 PSIG

TO SEE CHANNEL 20 FROM CHANNEL 10

PRESS 

TIMERS ACTIVE

STATUS TIMERS ACTIVE
NOT ARMED
CHAN 10
ENGINE OIL PRESSURE

STATUS TIMERS ACTIVE
NOT ARMED
CHAN 10
ENGINE OIL PRESSURE

TO SEE CHANNEL 21 FROM CHANNEL 20

PRESS 

TIMERS ACTIVE

STATUS TIMERS ACTIVE
ARMED
CHAN 20
MANIFOLD PRESSURE

STATUS TIMERS ACTIVE
ARMED
CHAN 20
MANIFOLD PRESSURE

TO SEE CHANNEL 40 FROM CHANNEL 21

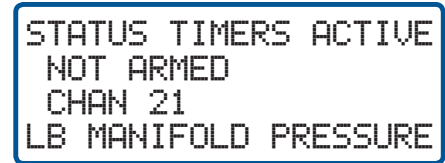
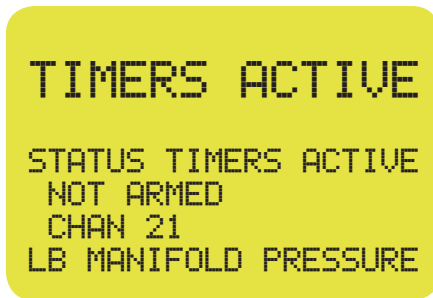

TO SEE CHANNEL 41 FROM CHANNEL 40

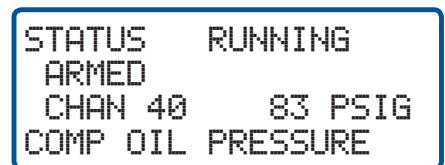
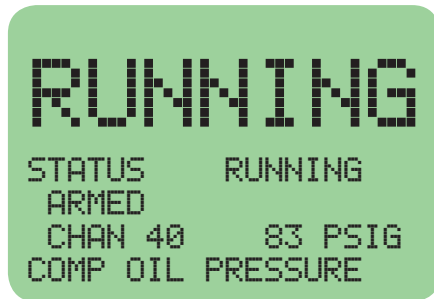

TO EXIT VIEW CHANNELS MODE

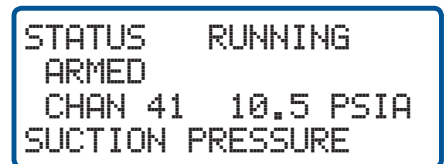

12.0 SHUTDOWN OR FAULT STATUS SCREENS

- 12.1 With the engine running and the controller system monitoring points, if a fault occurs, the display will show the first fault detected. The phrase 1ST FAULT and AL12 will be displayed; AL1 is for the first output, AL12 is for outputs one and two. The output or outputs configured for that channel will trip. The first fault will stay displayed on the screen until it is acknowledged by one of the keypad keys RESET or ESC. Use VIEW CHAN key to view the status of all channels.

After all of the current faulted channels are displayed, the display will revert to the first fault. If no class A sensors are faulted, pressing the RESET key will clear all displayed faults and return the display to the timers active home screen. All class B and C input timers and the output timers will be reset. Pressing the ESC key when the fault screen is displayed will return the display to the fault home screen. To again view the first fault from the fault home screen, press the VIEW CHAN key.

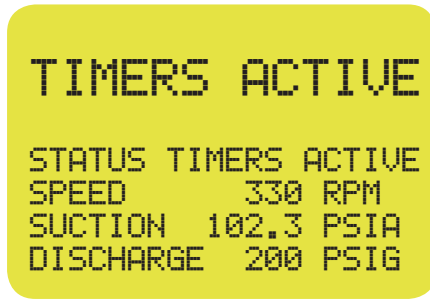
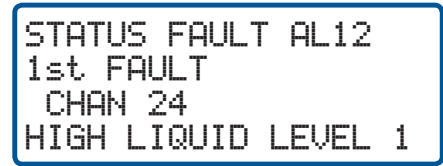

PRESS TO RESET TIMERS AND OUTPUTS



OR PRESS ESC FOR FAULT HOME SCREEN

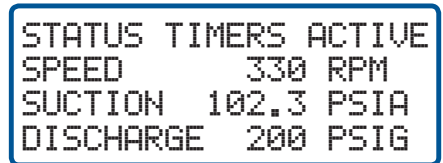

12.2 When a fault occurs on an analog channel, a HIGH or LOW indication will additionally be displayed as to whether the point faulted on a high or low setpoint.

A HIGH SETPOINT FAULTED ON AN ANALOG INPUT. THE ANALOG VALUE AND "HIGH" ARE DISPLAYED.

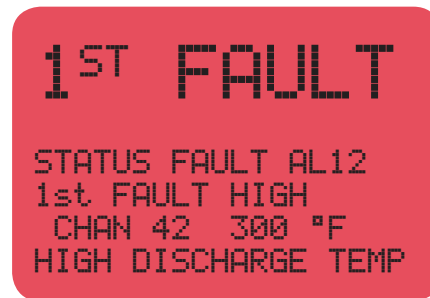

PRESS TO RESET AND TO CLEAR FAULT

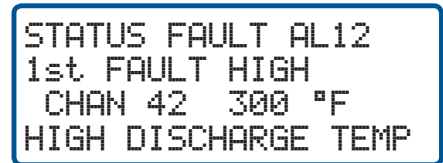

13.0 TEST MODE SCREENS

13.1 The test mode is used for testing sensors without tripping the outputs. The controller system stays in the test mode for a preset timed period. To enter the test mode, make sure the home screen status line says RUNNING, and press the TEST key on the keypad. The status line will display TEST xxx SEC; xxx being the remaining test time. To test an input, momentarily fault a sensor. The display will show the faulted point, its description and 1st FAULT for the first point tested. To test another point press the TEST key, this will clear the tested sensor from the display and will refresh the test timer to its full programmed test time.

WARNING: TEST MODE DISARMS ALL OUTPUTS. ACTUAL FAULTS WILL DISPLAY BUT WILL NOT TRIP THE SYSTEM ALARM AND SHUTDOWN OUTPUTS. USE MANUAL STOP FOR EMERGENCY SHUTDOWN.

PRESS TO ENTER TEST MODE

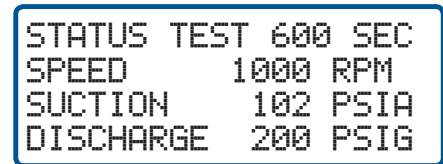
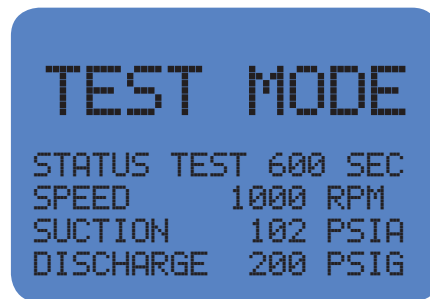

TEST SCREEN IS SHOWN WITH NO FAULTED POINTS. TEST KEY WAS PRESSED FROM THE "RUNNING" HOME SCREEN.

SENSOR
POINT 24
IS TESTED

```

TEST MODE
STATUS TEST 525 SEC
1st FAULT
CHAN 24
LIQUID LEVEL STAGE 1
    
```

PRESS
TO TEST
ANOTHER
SENSOR

TEST

```

STATUS TEST 525 SEC
1st FAULT
CHAN 24
LIQUID LEVEL STAGE 1
    
```

- 13.2 When any of the analog channels are tested, a HIGH or LOW indication will be displayed indicating whether a high or low setpoint was tested. The display will show the current analog value for the channel selected.

A HIGH
SETPOINT
FAULTED ON
AN ANALOG
INPUT

```

TEST MODE
STATUS TEST 530 SEC
1st FAULT
CHAN 33 5 PSIA
HIGH FILTER PRESS
    
```

```

STATUS TEST 530 SEC
1st FAULT
CHAN 33 5 PSIA
HIGH FILTER PRESS
    
```

- 13.3 If no sensors are faulted and the TEST key is pressed, the display will return to the test home screen. The test timer will be reset and speed, suction and discharge values will be displayed.

PRESS

TEST

```

TEST MODE
STATUS TEST 600 SEC
SPEED 1000 RPM
SUCTION 102.3 PSIA
DISCHARGE 200 PSIG
    
```

```

STATUS TEST 600 SEC
SPEED 1000 RPM
SUCTION 102.3 PSIA
DISCHARGE 200 PSIG
    
```

- 13.4 To exit the test screen, press either the ESC or CANCEL TIMERS key. Pressing the CANCEL TIMERS key takes the user to the STATUS RUNNING home screen and does not reset the class B, C and output timers. Pressing the RESET key takes the user to the STATUS TIMERS ACTIVE home screen with the class B, C and output timers reset.

PRESS

CANCEL
TIMERS

```

RUNNING
STATUS RUNNING
SPEED 1000 RPM
SUCTION 102.3 PSIA
DISCHARGE 200 PSIG
    
```

```

STATUS RUNNING
SPEED 1000 RPM
SUCTION 102.3 PSIA
DISCHARGE 200 PSIG
    
```

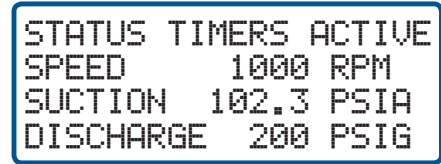
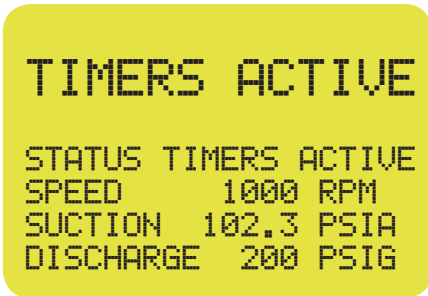

14.0 COOL-DOWN SCREEN

14.1 The cool-down mode enables the engine to enter a state before shutting down where a number of sensors may normally fault low. Class B and C channels that are configured for cool-down will not cause a fault during cool-down mode if an input falls below the corresponding low safety setpoint (analog channels) or switches out of its normal condition (discrete channels).

To enter cool-down mode, from the home screen, press the F2 key.

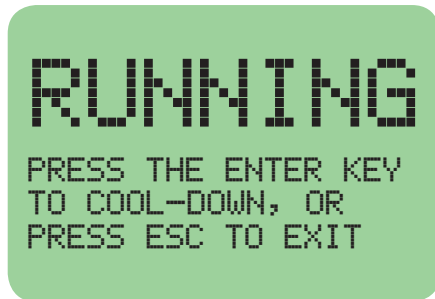

Pressing enter will start the cool-down timer and activate the cool-down channels. The status line on the home screen will display COOLDOWN xxx s; xxx being the remaining cool-down time. Channels that are not programmed as cool-down channels may still cause faults during this time.

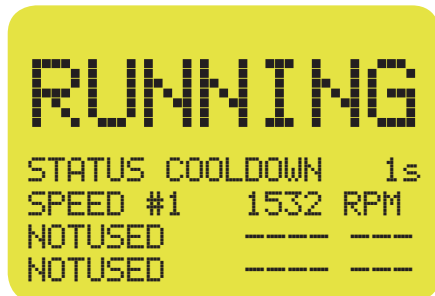

When the cool-down timer expires, the home screen status line will read FAULT AL12 with the description, COOL-DOWN SHUTDOWN.



15.0 VIEWING/EDITING THE CONFIGURATION USING THE MENU MODE

- 15.1 The menu screens can be accessed from any home screen (except test) by pressing the MENU key. The menu screens allow the user to view or edit global values, and the time and date. The controller must be initially configured using the terminal program running on a PC connected to the RS-232 or USB port on the back of the controller. Reference the programming instructions (section 30.0) for instructions on how to configure the controller system for a specific application. The menu screens are intended to view or edit the already programmed values in the field. Changes made in the menu are stored in permanent memory and remain fixed until changed again. Listed below are the values that can be viewed or edited:

VIEW or EDIT THE GLOBAL VALUES:

TEST TIME — from 1 to 999 seconds

NODE NUMBER — from 1 to 99 (default is 1)

CLASS C TIMER — from 1 to 999 minutes

VIEW THE INPUT CLASS:

The input class options are:

— **Class A** — no time delay on start-up

— **Class B** — 10 to 999 seconds time delay on start-up before input is active

— **Class C** — safe-until-first-met with a global time delay

VIEW or EDIT THE OUTPUT CONFIGURATION:

CONFIGURATION

— **N/O (Normally-open)** open in the normal run state and closes upon a fault

— **N/C (Normally-closed)** closed in the normal run state and opens upon a fault or loss of 12-24Vdc input power

— **IGN (Ignition Shorting and Fuel Valve Trip Module, Altronic P/N 691124)** open in the normal run state and closes upon a fault or loss of 12-24Vdc

ACTIVATION DELAY TIME — from 0 to 99 seconds

VIEW or EDIT THE TIME AND DATE:

TIME or DATE

- 15.2 To VIEW the controller configuration from the home screen, press the MENU key. Use the NEXT key to select the group to be viewed and press ENTER. To EDIT the controller configuration, the controller system requires a password key sequence. See section 27.0
- 15.3 The following keys have the same effect in all of the menu screens. If no key is pressed within one minute, the menu screen will time out and return to the current home screen.

NEXT: The NEXT key moves the selection arrow to the next selection or value with making a change to the previous value.

↑UNITS: The ↑UNITS key moves the selection arrow up one selection or increases the value by one.

↓UNITS: The ↓UNITS key moves the selection arrow down one selection or decreases the value by one.

→TENS: The →TENS key increases the value by ten.

←TENS: The ←TENS key decreases the value by ten.

ENTER: The ENTER key saves the new value and advances the selection arrow to the next value to be changed.

ESC: The ESC key returns the display back to the previous level of menu screens and when pressed again back to the current home screen.

15.4 The menu screens have two levels. The first level lists the headings of the items to be viewed or edited. Upon selecting one of the headings, the second level is displayed. Press the MENU key to enter the first level of the menu screens. The arrow points to the first selection to be viewed or edited. Three keys can be used to navigate the first level of menu selections, NEXT or ↑UNITS or ↓UNITS keys. The NEXT key will move the arrow down one selection. The ↑UNITS or ↓UNITS keys will move the selector arrow up or down one selection. Once the arrow is pointing to the selection group to be edited, press the ENTER key. The display will advance to the second level to view or allow changes to the values.



Use the following keys to navigate the menu screen.

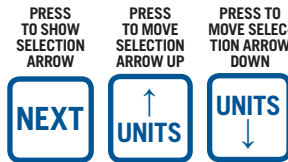

15.5 To edit the setpoint values, point to EDIT CONTROL VALUES and press the ENTER key. The edit control values menu is shown. The arrow points to EDIT SETPOINTS.

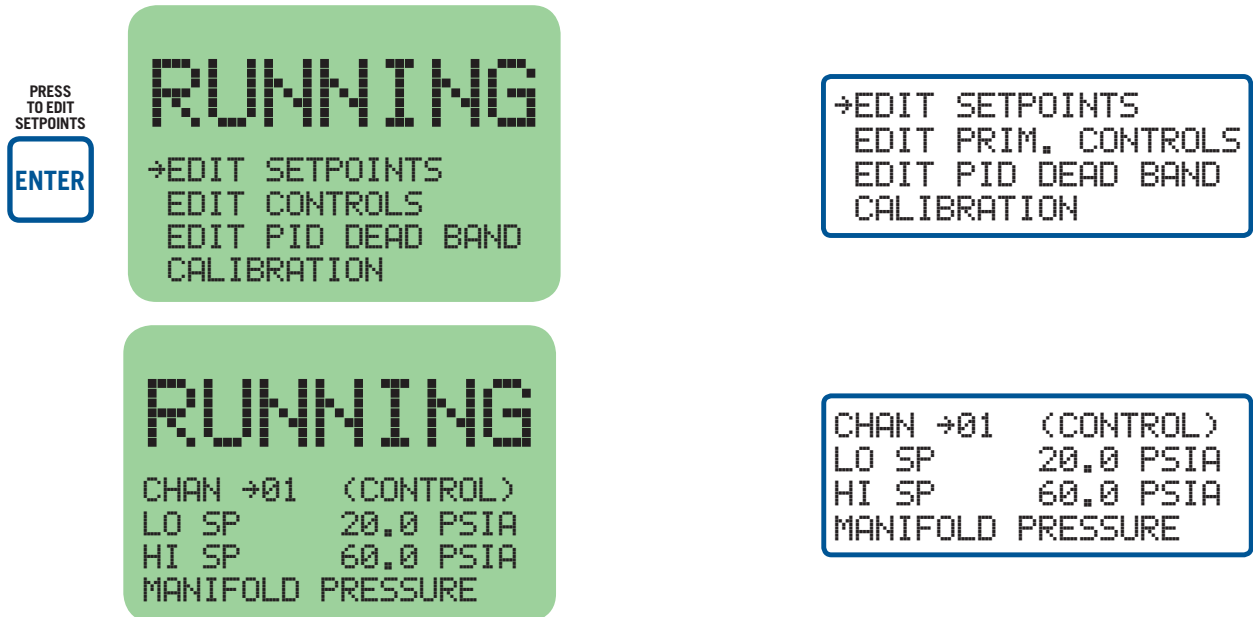

15.6 To edit Primary Controls or Linear/Ramp Control, first select EDIT CONTROL VALUES from main menu and press the ENTER key. The edit control values menu is shown. The arrow points to EDIT CONTROLS.

PRESS
TO EDIT
CONTROLS

ENTER

RUNNING

EDIT SETPOINTS
→EDIT CONTROLS
EDIT PID DEAD BAND
CALIBRATION

EDIT SETPOINTS
→EDIT PRIM. CONTROLS
EDIT PID DEAD BAND
CALIBRATION

PRESS
TO EDIT
LIN/RAMP
CONTROLS

ENTER

RUNNING

>LINEAR/RAMP CONTROL
EDIT PRIM. CONTROLS

To edit Linear/Ramp Control, in the EDIT CONTROLS screen, select LINEAR/RAMP CONTROL and press enter.

RUNNING

VAR LOW > 5.0 PSIA
OP LIMIT 6.0 mA
VAR HIGH 20.0 PSIA
OP LIMIT 17.9 mA

Here the low and high setpoints and corresponding currents can be adjusted using the up/down or left/right arrows. Once a desired value has been programmed, press ENTER to move to the next parameter. To edit the Solenoid Pulse Control, in the EDIT CONTROLS screen, select EDIT PRIM. CONTROLS and press ENTER.

RUNNING

CONTROL → 18.0 PSIA
CYCLE TIME 5 s
PROP. BAND 40 %
DEAD BAND 2.2 PSIA

CONTROL → 18.0 PSIA
CYCLE TIME 5 s
PROP. BAND 40 %
DEAD BAND 2.2 PSIA

15.7 To edit PID Deadband, select EDIT PID DEADBAND and press ENTER.

PRESS TO
EDIT PID
DEADBAND

ENTER

RUNNING

EDIT SETPOINTS
EDIT CONTROLS
→EDIT PID DEADBAND
CALIBRATION

EDIT SETPOINTS
EDIT PRIM. CONTROLS
→EDIT PID DEADBAND
CALIBRATION

Use the ENTER key to select which PID DEADBAND to modify. Use the arrow keys to change the values.

RUNNING

PID #1
DEADBAND→ 0.0 PSIA
PID #2
DEADBAND 2.5 PSIA

PID #1
DEADBAND→ 0.0 PSIA
PID #2
DEADBAND 2.5 PSIA

15.8 The calibration feature allows the user to make adjustments in order to 'tweak' the sensor's reading to best match known conditions. For each analog input, the ZERO and SPAN values may be modified.

RUNNING

EDIT SETPOINTS
EDIT CONTROLS
EDIT PID DEADBAND
→CALIBRATION

EDIT SETPOINTS
EDIT PRIM. CONTROLS
EDIT PID DEADBAND
→CALIBRATION

RUNNING

CHAN →01
ZERO CALIBRATION
SPAN CALIBRATION
23.1 PSIA

CHAN →01
ZERO CALIBRATION
SPAN CALIBRATION
23.1 PSIA

From this menu, the UP and DOWN arrow keys are used to select the analog channel which needs to be calibrated. The value on the bottom shows the actual value of that channel which is being calibrated. Make sure to enter the password to modify the calibration.

PRESS TO
SELECT ZERO
CALIBRATION

ENTER

```

RUNNING
CHAN 01
→ZERO CALIBRATION
SPAN CALIBRATION
14.5 PSIA
    
```

```

CHAN 01
→ZERO CALIBRATION
SPAN CALIBRATION
14.5 PSIA
    
```

The ZERO CALIBRATION adjustment allows the user to increase or decrease the zero calibration of an analog channel. Pressing the UP arrow key several times will increase the displayed value.

```

RUNNING
CHAN 01
→ZERO CALIBRATION
SPAN CALIBRATION
14.7 PSIA
    
```

```

CHAN 01
→ZERO CALIBRATION
SPAN CALIBRATION
14.7 PSIA
    
```

The previous example could be used to calibrate a pressure sensor to sea level. Changing the ZERO CALIBRATION will have the same effect to the high end of the transducer range as the low.

PRESS TO
SELECT SPAN
CALIBRATION

ENTER

```

RUNNING
CHAN 01
ZERO CALIBRATION
→SPAN CALIBRATION
145.6 PSIA
    
```

```

CHAN 01
ZERO CALIBRATION
→SPAN CALIBRATION
145.6 PSIA
    
```

The SPAN CALIBRATION adjustment allows the user to increase or decrease the span calibration of an analog channel. Pressing the UP arrow key several times will increase the displayed value.

Unlike the zero calibration, the span calibration will have a larger change for higher numbers.

- 15.9 To view or edit safety shutdown values, choose EDIT SAFETY SHUTDOWN from the main menu. To edit or view setpoints choose EDIT SETPOINTS.

```

RUNNING
EDIT CONTROL VALUES
→EDIT SAFETY SHUTDOWN
HOURMETER FUNCTIONS
VIEW FIRMWARE REV.
    
```

```

EDIT CONTROL VALUES
→EDIT SAFETY SHUTDOWN
HOURMETER FUNCTIONS
VIEW FIRMWARE REV.
    
```

```

RUNNING
→EDIT SETPOINTS
EDIT INPUT CLASS
EDIT GLOBAL VALUES
MORE MENUS
    
```

```

→EDIT SETPOINTS
EDIT INPUT CLASS
EDIT GLOBAL VALUES
MORE MENUS
    
```

```

RUNNING
CHAN →01 (SAFETY)
LO SP 20.0 PSIA
HI SP 60.0 PSIA
MANIFOLD PRESSURE
    
```

```

CHAN →01 (SAFETY)
LO SP 20.0 PSIA
HI SP 60.0 PSIA
MANIFOLD PRESSURE
    
```

15.10 To view input class, choose EDIT SAFETY SHUTDOWN from main menu. Select VIEW INPUT CLASS from next menu.

```

RUNNING
EDIT SETPOINTS
→EDIT INPUT CLASS
EDIT GLOBAL VALUES
MORE MENUS
    
```

```

EDIT SETPOINTS
→EDIT INPUT CLASS
EDIT GLOBAL VALUES
MORE MENUS
    
```

```

RUNNING
CHAN →01
INPUT CLASS *A B C
300 SECONDS TIME
DELAY ON START-UP
    
```

```

CHAN →01
INPUT CLASS *A B C
300 SECONDS TIME
DELAY ON START-UP
    
```

Channel 01's input class configuration will be displayed. Each input channel 01–60 can be either class A, B, or C. The class for analog input channels is programmed in the terminal program using the PC, both the high and low setpoints of these channels are individually selectable. A diamond next to the input class letter selects that class for the displayed channel.

PRESS TO
VIEW THE
INPUT CLASS
OF CHANNEL
20

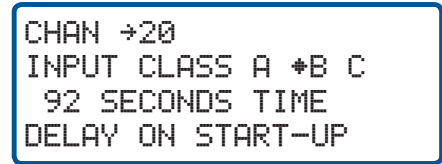
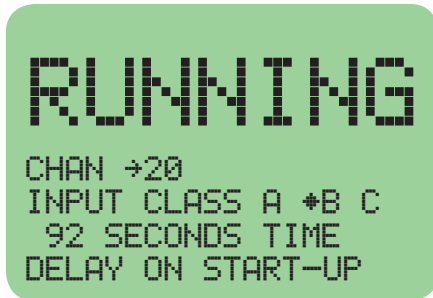

To view the next channel number, press the NEXT key until the arrow points to the channel number. Select another channel number by using the ↑UNITS or ↓UNITS keys to increase or decrease the channel by one or use the →TENS or ←TENS key to increase or decrease the channel by ten and press ENTER.

- 15.11 To edit global values, select EDIT SAFETY SHUTDOWN from main menu. Select EDIT GLOBAL VALUES from next menu.

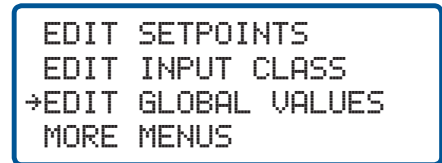

PRESS TO
EDIT THE
GLOBAL
VALUES

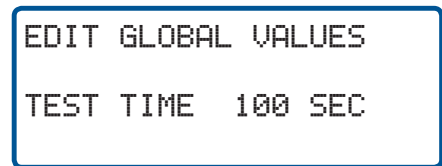

To change the test time, use the ↑UNITS or ↓UNITS keys to increase or decrease the value by one. Use the →TENS or ←TENS keys to increase or decrease the value by ten. Press the ENTER key to save the new value and advance to the next value.

- 15.12 To edit the output configuration, choose EDIT SAFETY SHUTDOWN from the main menu. Select MORE MENUS from the following menu. Finally, select OUTPUT CONFIG. from the last menu.

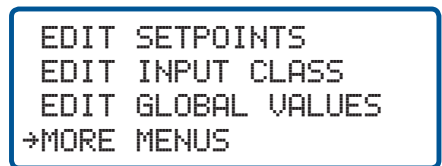

```

RUNNING
→OUTPUT CONFIG.
EDIT TIME AND DATE
COMMUNICATIONS
TO PREVIOUS MENU
    
```

```

→OUTPUT CONFIG.
EDIT TIME AND DATE
COMMUNICATIONS
TO PREVIOUS MENU
    
```

```

RUNNING
OUTPUT→ 1 2
DELAY TIME 0 SEC
N/O N/C IGN
    
```

```

OUTPUT→ 1 2
DELAY TIME 0 SEC
N/O N/C IGN
    
```

A selection arrow pointing to output 1, along with its delay time and a diamond showing whether it is configured for N/O (normally-open), N/C (normally-closed), or IGN (ignition output module 691124), will be shown. To view the configuration, use the NEXT or →TENS or ←TENS keys to place the selection arrow in front of the output to be viewed. The time delay and output state will be shown for each output.

```

RUNNING
OUTPUT→1 2
DELAY TIME 0 SEC
N/O N/C *IGN
    
```

```

OUTPUT→1 2
DELAY TIME 0 SEC
N/O N/C *IGN
    
```

To edit a configuration, use the NEXT or →TENS or ←TENS keys to place the selection arrow in front of the desired output and press the ENTER key. The selection arrow will point to the delay time. Each output switch can have its own activation delay time from 0 to 999 seconds. An output switch with a delay time of 0 seconds will trip immediately upon a fault. If a delay time is set for an output switch, the output will trip following a fault plus the delay time selected. This allows, for example, a delay time between when the fuel valve trips on output 1 and when the ignition shorts on output 2.

```

PRESS
NEXT
RUNNING
OUTPUT 1 →2
DELAY TIME 3 SEC
N/O N/C *IGN
ENTER
    
```

```

OUTPUT 1 →2
DELAY TIME 3 SEC
N/O N/C *IGN
    
```

A diamond will replace the arrow in front of the selected output switch. An arrow will precede the delay time indicating a change can be made to the delay time of the selected output. Use the ↑UNITS or ↓UNITS keys to increase or decrease the value by one or use the →TENS or ←TENS key to increase or decrease the value by ten. The ENTER key accepts the change and advances the pointer to select either N/O, N/C or IGN.



PRESS TO
ACCEPT THE
CHANGE IN
VALUE

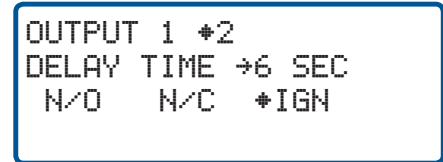

The selection arrow replaces the diamond indicating a change can be made. The selected output switch can be configured for N/O (normally-open), N/C (normally-closed), or IGN (ignition module 691124).

An output switch configured for normally-open will be open in the normal run state and close upon a fault.

An output switch configured for normally-closed will be closed in the normal run state and will open upon a fault or loss of 12-24Vdc input power.

An output switch configured for the ignition module will be open during normal run and will close upon a fault or loss of 12-24Vdc input power. Use the NEXT key to make a selection and press ENTER to save.

NOTE: THE IGN SELECTION IS INTENDED FOR THE ALTRONIC OUTPUT MODULE 691124 ONLY. THE IGN SELECTION CAN BE MADE FOR OUTPUT SWITCH NUMBERS 1 AND 2 ONLY.

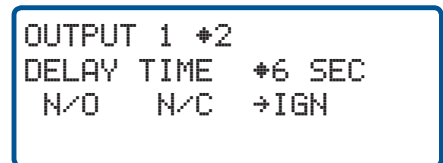

Upon pressing the ENTER key, a diamond will replace the selection arrow. To view or edit the next output number, press the NEXT or →TENS or ←TENS keys until the arrow points to the desired output number and repeat the process.

- 15.13 To view or edit the time and date, select EDIT SAFETY SHUTDOWN from the main menu. Select MORE MENUS from the following menu. Finally, select EDIT TIME AND DATE from the last menu.

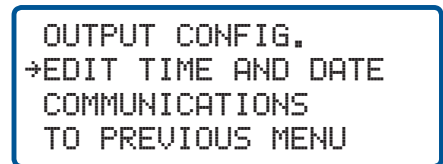

The time and date will be displayed with the selection arrow pointing to the time. The hours, and minutes can be edited separately, AM and PM follow the hours. With the selection arrow pointing to the hours, use the ↑UNITS or ↓UNITS keys to increase or decrease the hours. Press ENTER to save the new hour setting; the selection arrow will point to the minutes. Use the same procedure to edit the minutes. Use the NEXT key to move through the time and date screen without making a permanent change in memory.

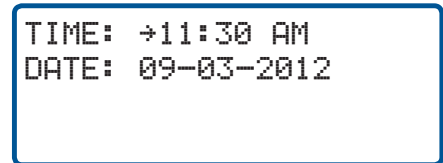

The date is shown as month-day-year. The month, day and year can be edited separately. With the selection arrow pointing to the month, use the ↑UNITS or ↓UNITS keys to increase or decrease the month. Press ENTER to save the new month setting; the selection arrow will point to the day. Use the same procedure to edit the day and the year.

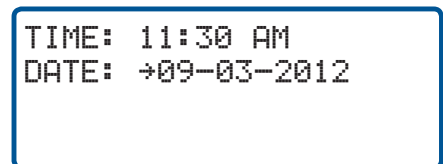

15.14 To view or edit the communications setup, select COMMUNICATIONS from the menu and press ENTER.

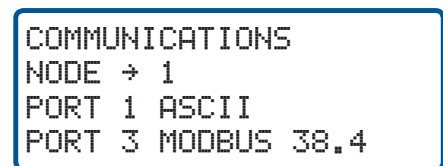

Use the NEXT key to select node, port 1 or port 3; then use the UP or DOWN arrow keys to change the node number from 1 to 99 and port 1 and port 3 from ASCII to MODBUS. Press ENTER to save selection.

15.15 To view Hourmeter and Servicemeter messages, select HOURMETER FUNCTIONS from the main menu and press ENTER.

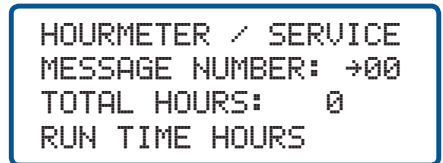

Use the UNITS and TENS keys to view the eleven, user-programmable service messages. The F2 key can be used to reset the servicemeter timer for each individual message number.

15.16 3-Tier Hourmeter Functions – NEW 2019 FEATURE

Display firmware for 2019 and later has a 3-Tier Hourmeter to track hours typical for engine applications. The new categories for hourmeters are “MASTER”, “DRIVER”, and “DRIVEN EQUIPMENT”. Each hourmeter may be re-programmable through the keypad or Modbus registers. These hourmeter values are 32 bit which allows the user to select values within the range of 0 to 4294967295 hours. These values are not re-programmable from the PC terminal program, which prevents accidental overwrites of the data. These Hourmeters will increment when RPM is greater than zero.

Selecting ‘HOURMETER FUNCTIONS’ will show the following:

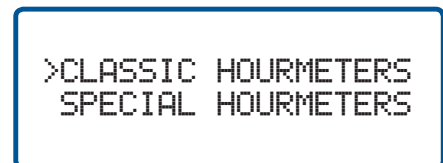

Selecting the 'Classic Hourmeters' will show the menu as shown in section 15.15. Selecting 'SPECIAL HOURMETERS' will show the following:

```

MANUAL STOP
>MASTER      14313
DRIVER       7302
DRV EQ.      70201
EDIT HOURS   15
    
```

```

>MASTER      14313
DRIVER       7302
DRV EQ.      70201
EDIT HOURS   15
    
```

This screen now displays the given Hourmeter values.

This menu has a password (15) and allows you to change values for the various Hourmeters.

Use the UP arrows to select '15' for the password.

Press the ENTER key to modify values.

Use the UP/DOWN/RIGHT/LEFT to increment/decrement the specific hourmeter. You may also press F1 to increase by 100 and F2 to increase by 1000. Press the RESET key to zero out the hourmeter. Pressing ENTER saves the selection.

These values may also be read/written by Modbus registers. Only Modbus function 6 is supported for writes.

MAIN – 44655, 44656

DRIVER – 44657, 44658

DRIVEN EQUIPMENT – 44659, 44660

15.17 To view the firmware revisions of the DISPLAY and TERMINAL modules, select VIEW FIRMWARE REV. from the main menu then press ENTER.

```

RUNNING
EDIT CONTROL VALUES
EDIT SAFETY SHUTDOWN
HOURMETER FUNCTIONS
→VIEW FIRMWARE REV.
    
```

```

EDIT CONTROL VALUES
EDIT SAFETY SHUTDOWN
HOURMETER FUNCTIONS
→VIEW FIRMWARE REV.
    
```

```

RUNNING
DE-3000
DISPLAY: 05/12/12
TERMINAL: 04/02/12
SPECIAL: 000001
    
```

```

DE-3000
DISPLAY: 05/12/12
TERMINAL: 04/02/12
SPECIAL: 000001
    
```

NOTE: SPECIAL FIRMWARE VERSIONS WILL DISPLAY FILE REFERENCE NUMBER ON BOTTOM LINE.

16.0 VIEWING THE TIME AND DATE OF THE FIRST FAULT

- 16.1 The DE-3000 controller system “stamps” the time and date occurrence of the first fault. To view the time and date of the first fault, press the F2 key after a fault occurs but before reset is initiated. The time and date of the first fault will be displayed. If no key is pressed for 10 seconds, the display will revert to the first fault screen. Press the ESC key to return to the current home screen.



RUNNING
TIME AND DATE OF
THE FIRST FAULT.
TIME: 3:10 PM
DATE: 03-25-2012

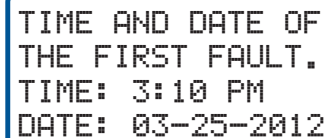

TIME AND DATE OF
THE FIRST FAULT.
TIME: 3:10 PM
DATE: 03-25-2012

17.0 CONTRAST RATIO ADJUSTMENT (CLASSIC DISPLAY ONLY)

- 17.1 The LCD contrast ratio is set at the factory for optimum contrast over a large temperature range. It may be necessary however to make slight adjustments to the LCD contrast ratio because of aging and or extreme temperature changes. The contrast ratio potentiometer (TP1) is located on the back of the Display Module as shown in the drawings section. Use an adjusting tool and turn the potentiometer clockwise to lighten the contrast ratio or counterclockwise to darken the contrast ratio.

To set the potentiometer back to the factory setting: with the Display Module at an ambient temperature of approximately 65°F to 77°F (18°C to 25°C), turn the potentiometer clockwise until the display contrast ratio is almost too light to read. Turn the potentiometer counterclockwise 3 to 3-1/2 turns. The display should now be at a desirable contrast ratio.

18.0 DATA LOGGING AND COMMUNICATION OPTIONS

- 18.1 The DE-3000 controller system contains a data logging feature. Data logging collects information from the system and keeps track of, or logs, that information over a period of time. That data is then available through a PC or PLC at port 1, the RS-232 port or port 3, the RS-485 port.

18.2 NODE NUMBER

The node number is the address of the controller being contacted. This number is programmed by the terminal program and can be viewed or edited in the menu screen, refer to section 15.14. A two-digit number from 01 to 99 can be used.

18.3 COMMUNICATIONS PARAMETERS

The following must be set in the PC or PLC to communicate with the controller system:

- Baud Rate: 9600
- Data Bits: 8
- Stop Bits: 1
- Parity: None

- 18.4 The data logging memory can retain a total of 100 records before writing over the oldest information. The most current data is always record number one; the next most current is number two, etc. The oldest information, record 100, is lost when a new record is written. The logging period is the time between data logs and can be set from 5 minutes to 999 minutes. The logging period must be set in the terminal program. Reference the programming instructions (section 30.0) to set the logging period. So, for example, if the logging period is set for 60 minutes and there are 100 records, it would take 100 hours or 4.16 days before any logged data was overwritten.

A new record is also written when a first fault occurs. If the first fault occurs between the logging period, the first fault record will be record number one and the next scheduled record will be number two.

18.5 The DE-3000 system uses a simple ASCII command to read the data collected. The ASCII command must be transmitted to the controller by the PC or PLC before it can respond. The command is shown below. The hexadecimal values for the characters are shown only for those using low level (assembly language) decoding and will not appear on the communications terminal screen.

ASCII >(01 DL 001)

HEX 3Eh 28h 30h 32h 20h 44h 4Ch 20h 30h 30h 32h 29h

COMMAND HEADER ">" (3Eh) The command must begin with the command header.

START OF TEXT "(" (28h) The start of text character must be next.

NODE NUMBER 01–99 The node number or address of the controller being contacted is next. This number is programmed by the terminal program and can be viewed or edited in the menu screen. A two digit number from 01 to 99 can be used.

SPACE (20h) Following the node number is an ASCII space character (not printable, value 20h) to act as a delimiter between the node number and the two character command word.

COMMAND WORD "DL" (44h, 4Ch) The command is an upper case DL for data log.

SPACE (20h) A space again is used as a delimiter.

RECORD NUMBER 001–100 The record number is the requested record. This number can be any number from 001 to 100. Record number 001 always contains the most recent record, 002 the second most recent and so on. The controller holds a maximum of 100 records in its memory before overwriting the oldest record.

END OF TEXT ")" (29h) The end of text completes the message.

18.6 One record contains the following information:

COMP. STATION #01 GIRARD, OHIO	User entered data log header describing location
001 10333 HRS	Record number and running hours
10-19-1998 9:46 AM	Date/time the record information was collected
STATUS RUNNING	Normal home screen status line
SPEED 925 RPM	Normal home screen, line two
SUCTION 102.3 PSIA	Normal home screen, line three
DISCHARGE 300 PSIG	Normal home screen, line four
PRESS 1 102.3 PSIG	* First view process screen, line one
PRESS 2 355 PSIG	* First view process screen, line two
PRESS 3 250 PSIG	* First view process screen, line three
PRESS 4 275 PSIG	* First view process screen, line four
TEMP 1 55 °F	* Second view process screen, line one
TEMP 2 170 °F	* Second view process screen, line two
TEMP 3 180 °F	* Second view process screen, line three
TEMP 4 190 °F	* Second view process screen, line four
TEMP 5 220 °F	* 11th Analog channel value
PRESS 5 22 PSIA	* 12th Analog channel value
USER LABEL	* 13th Analog channel value
USER LABEL	* 14th Analog channel value
1ST FAULT HIGH	** First fault indication when fault occurs
CHAN A3 500 PSI	** Channel number and value of first fault
HIGH INTRSTAGE PRESS	** 20 character label associated with the first fault
10-19-1998 9:46 AM	** Date and time of the first fault

* If a view process screen line is not programmed in the controller, the line will be blank.

** These lines will be blank when there are no faults.

18.7 If it is desired to read more than one record, the read command can be sent in succession with a different record number. The time between read commands should be one second or longer.

18.8 The first fault data log record can be read remotely if a current fault exists in the controller. Send the following ASCII command for the first fault data log:

>(01 DL 999)

01 is the node number and should match the controller. 999 is where the current first fault is located. If this command is sent with no faults on the controller, it will respond with NO DATA AVAILABLE.

18.9 The most current data can be read remotely by sending the following ASCII command:

>(01 DL 000)

18.10 The DE-3000 system can be reset or stopped remotely by sending a serial command string.

REMOTE RESET >(01 AUTO)
REMOTE STOP >(01 STOP)

18.11 The DE-3000 is compliant to the Modicon Modbus RTU standard. The DE-3000 only supports register reads; data is duplicated for the 30000's and 40000's address range. Maximum number of registers that can be read at one time has been limited to 32.

18.12 IDENTIFICATION

In addition to the above, the DE-3000 will respond to function code 17 with an identification string as follows:

Query:

NN 17 CRC CRC

Where:

NN = node number, **17** = ID function code, **CRC CRC** = two byte Modbus RTU CRC.

Response:

NN 17 07 DE - 3 0 0 0 CRC CRC

Where:

NN = node number, **17** = ID function code, **07** = number of bytes to follow, **DE-3000** (seven byte ASCII ID string), **CRC CRC** = two byte Modbus RTU CRC

18.13 REMOTE STOP/RESET

Register 40999 can be written to remotely trigger the stop and reset functions. It will respond to a single write only (function code 06). The stop command is **0x53AC**. The reset command is **0x41BE**.

18.14 PORT 4

Not active. Reserved for future use.

18.15 PORT 5

Not active. Reserved for future use.

18.16 REMOTE OPERATOR INTERFACE

The DE-3000 has a feature called the Remote Operator Interface (ROI) that can be accessed through function code 20. This feature makes it possible for any function normally accessible locally on the keypad to be implemented remotely via Modbus. Since the response to the Key Press commands automatically returns the current display on the device, a possible conflict between local and remote control authorities can be readily avoided and the actual device status on the display is known at both locations.

Query:

NN 20 KP CRC CRC

Where:

NN = node number, **20** = KP function code, **KP** is the single byte “Key Press” from the table below, **CRC CRC** = two byte Modbus RTU CRC.

Key Press Table

00 = NONE (no keypress, returns current display)

01 = CANCEL TIMERS

02 = TEST

03 = RESET

04 = STOP

05 = VIEW

06 = NEXT

07 = UP/UNITS

08 = VIEW CHAN

09 = F1

10 = RIGHT/TENS

11 = ENTER

12 = LEFT/TENS

13 = F2

14 = MENU

15 = DOWN/UNITS

16 = ESC

Response:

NN 20 88 (20 bytes 1st line of display) **CR LF** (20 bytes 2nd line) **CR LF** (20 bytes 3rd line) **CR LF** (20 bytes 4th line) **CR LF CRC CRC**

Where:

NN = node number, **20** = KP function code, **88** = number of bytes to follow, **CR** = Carriage Return, **LF** = Linefeed, 4 20-byte ASCII blocks that is the display, **CRC CRC** = two byte Modbus RTU CRC

19.0 AUTOMATIC CALL OUT USING AN EXTERNAL MODEM

- 19.1 The DE-3000 controller system can perform an automatic call out upon a fault condition. When a fault occurs, the system will dial up to four preprogrammed phone numbers stored in an external modem, negotiate communications and send the first fault data log report message (the 999 command) to the Altronic monitor program on a PC or to a customer supplied device.
- 19.2 An external modem of 9600 baud or greater, along with a null modem cable or adapter connected to the RS-232 port on the controller, is used for remote modem communications.

19.3 Configure the modem using the monitor program:

- **9600 baud only (S37=9)**
- **8 data bits**
- **1 stop bit**
- **no parity**
- **DTR is always on (&D0)**
- **Local Echo off (E0)**
- **Display verbal result codes (V1)**
- **Auto answer on the first ring (S00=1)**
- **Set inactivity timer to one minute (S19=1)**
- **Store the current configuration as profile 0 in nonvolatile memory (&W0)**
- **Use modem profile 0 (&Y0)**
- **Store up to four telephone numbers in nonvolatile memory (&Zn=x)**
 - n = memory location**
 - x = phone number to be stored**

For more information on configuring the modem, see section 30.10. Please refer to the modem's user guide and reference manual.

- 19.4 Upon a fault, the controller sends the dial string to dial the first stored phone number in the modem (ATDTSO). If communications are established, the first fault data log report message is sent. After the first fault message is sent, a pause of about ten seconds occurs allowing for time to request other data logs. After ten seconds of no activity, the controller causes the modem to go offline. The first fault data log is then available on the remote PC for customer use. If more than one phone number is programmed in the modem, the controller will attempt to dial each number until all numbers have been successfully negotiated. If the first stored phone number in the modem is not available, the controller will immediately dial the second stored phone number. After attempting to dial all of the programmed phone numbers and if any of them were not answered, a pause of 10 minutes will occur.

After the 10 minute wait period for the line to clear, the controller will send the dial string for the unanswered stored phone numbers. This sequence will occur twenty times or until it gets a connect signal for each programmed phone number. If all faults are cleared by initiating a reset, the controller will cease dialing out.

NOTE: THE RELATED MODEM CONFIGURATION COMMANDS ARE SHOWN IN PARENTHESIS. THE COMMANDS NOT LISTED ARE SET TO FACTORY DEFAULTS. MODEM PROFILE 0 (ZERO) IS USED BY THE CONTROLLER SYSTEM. UP TO FOUR PHONE NUMBERS CAN BE PROGRAMMED IN THE MODEM.

20.0 ALARM FUNCTION

20.1 OVERVIEW

The alarm function may occur on any of the analog or digital input channels. The channel is typically a point of concern, but not for safety protection. This allows the user to take action, while still allowing the engine to run.

20.2 FUNCTION

The status of an alarm condition may be viewed from the VIEW CHANNELS MODE. When a channel is in the alarm condition, the channel will display the ALARMED message and output #6 on the terminal board will turn on. This may be connected to a horn or a light. Press the F2 key on the ALARMED channel to silence the alarm (output #6).

The following is needed for the point to be in an alarm condition:

1. The unit must be setup for alarms.
2. The channel must be programmed for an alarm condition.
3. The channel must be timed out and armed.
4. The analog input channel must be violating its control setpoint (either high or low).
5. The digital input channel must be tripped but not in a faulting condition.
6. The unit cannot be in either a STOP or a faulted condition.

20.3 In the following example the high control setpoint for channel 12 is set for 25.0 PSIG

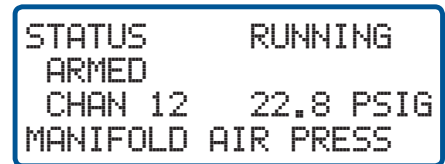

When the pressure goes above 25.0 the ALARMED message reads:

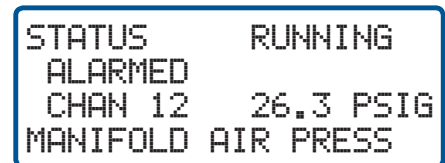

The alarm may be acknowledged by pressing the F2 key as shown:

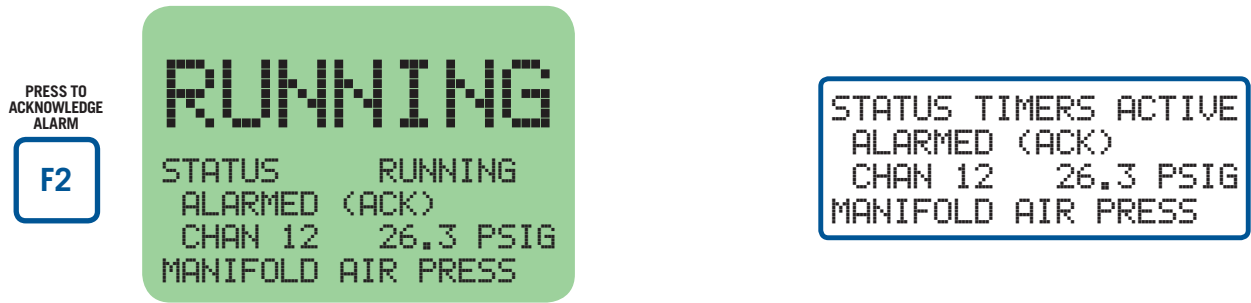

Acknowledging all the alarms will turn off output #6 (typically a horn or light).

Once the alarm is no longer violated, whether its been acknowledged or not, the 2nd line resumes displaying ARMED.

21.0 INTEGRATED TIMER OUTPUTS

21.1 On 2014 and later versions of the DE-3000, digital outputs #5 and #13 may be configured in the terminal program to be used as integrated timers. When configured for this function, the digital outputs turn ON at the engine start and remain ON until a specified amount of time has passed since a stop or fault. This may be used, for example, to shut down the power to a panel in order to lengthen battery life. The operation of the integrated timer output is depicted in the following diagram:

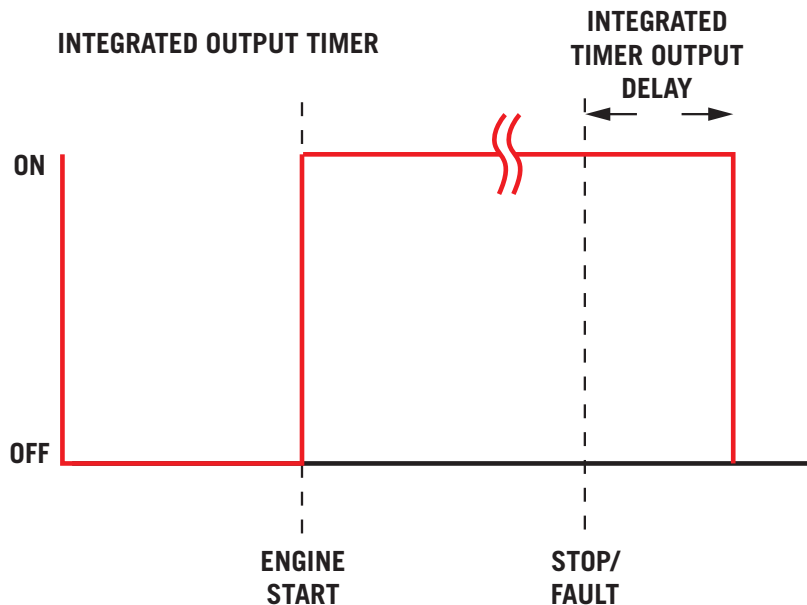

22.0 TROUBLESHOOTING

22.1 The power LED's on the Power Supply and Terminal Module are blank as well as the LCD on the display module:

- Check the power supply voltage at the 12-24Vdc input terminals; should be between 12 and 24Vdc.
- Check the power supply power fuse and replace if blown.
- If the Terminal Module power LED or the Display Module LCD is not on, make sure the 25-pin connectors and cable assembly are connected and secured.

NOTE: A SPARE FUSE (PART NUMBER 601653 - 6.3 AMP) IS PROVIDED ON THE POWER SUPPLY BOARD.

- 22.2 The normally-open sensors do not cause a fault:
- Make sure the power supply minus terminal is grounded to the panel and the panel is grounded to the engine block. They must all be at the same potential for normally-open sensors that use the engine block as a return path. Use an ohmmeter and measure between the power supply minus terminal and the panel and engine block — this reading should be less than 2 ohms.
- 22.3 The output LED's are changing state but the relays or solenoid valves connected to the outputs are not tripping:
- Check that the wiring is correct and check the output module fuse.
- 22.4 The power LED's are lit as well as the LCD backlighting but the LCD is blank or shows WARNING: THE DE-3000 Controller MUST BE CONFIGURED PRIOR TO USE ON AN ENGINE:
- The controller system needs to be configured. See programming instructions to configure the system.
- 22.5 The home screen displays NO COMM. message for either the speed, suction or discharge:
- Communications from the terminal PCB to the DE-3000 controller have been broken. Check cable connections.
- 22.6 The home screen displays dashes for the speed, suction or discharge:
- A channel was not configured in the initial configuration for that parameter. See programming instructions to reprogram the controller system.
- 22.7 The fault screen shows that outputs one and two should be tripping the fuel valve and shorting the ignition but the fuel valve and ignition do not trip:
- Make sure the fuel valve and ignition shutdown lead are wired to power supply terminals FV1 and FV2 for the fuel valve and IGN+ and IGN- for the ignition shutdown lead.
 - Make sure that Altronic output module 691124 is in power supply output slots OUT 1 and OUT 2.
- 22.8 The time and date, after being set (see section 15.13), are not correct after removing and reapplying the input power:
- The real time clock/RAM module (U10) needs replaced.
- 22.9 LCD contrast ratio on the Display Module is either too light or too dark:
- The contrast ratio needs to be adjusted. See section 17.0
- 22.10 The external modem does not commence dialing:
- A null modem cable or adapter is not used and is required from the RS-232 port to the modem.
 - The modem was not configured properly. Make sure that DTR is always on and that configuration 0 (zero) is being used and the phone numbers are programmed into the modem.

23.0 AUTO START OPTION

- 23.1 To automatically start the engine, the AUTO START option must be selected when programming the system from the PC and the starting procedure sequence defined.

STATE 0: SHUTDOWN

The AUTO START sequence must begin from an engine stopped condition, this means that the measured RPM has been at zero for at least 5 seconds. This is the system STATE 0 on the sequence chart.

WARNING: WHEN PROGRAMMED FOR MULTI-START, THE DE-3000 WILL AUTOMATICALLY ATTEMPT TO START THE ENGINE AS MANY AS FOUR TIMES. RESTARTS ARE MADE BETWEEN 30 AND 90 SECONDS FOLLOWING AN OVER-CRANK FAULT. PERSONNEL AROUND THE ENGINE MUST BE NOTIFIED TO TAKE THE NECESSARY SAFETY PRECAUTIONS TO AVOID INJURY OR MALFUNCTION.

NOTE: IF A CLASS A SETPOINT SHOULD FAULT AT ANY TIME DURING AN AUTO START SEQUENCE, THE SYSTEM WILL TERMINATE THE SEQUENCE AND DISPLAY THE APPROPRIATE FAULT MESSAGE RETURNING THE SYSTEM TO STATE 0.

NOTE: AUTO START IS INHIBITED BY SENSING ANY RPM ABOVE 0 RPM. AUTO START IS ABORTED BY THE DETECTION OF ANY MONITORED FAULT. CLASS B AND CLASS C TIMERS BEGIN AT CRANKING. A LOCAL WARNING SIGNAL AT THE ENGINE SITE PRIOR TO CRANKING SHOULD BE PROVIDED.

STATE 1: BEGIN AUTO START SEQUENCE TIMED DELAY PERIOD

When the auto start command is received, the first action taken is to create an internal system reset which clears the previously set fault flags and resets the PRE-LUBE (Timer 1) and DELAY BEFORE CRANKING (Timer 2) timers to a count of zero. This is system STATE 1. The PRE-LUBE and DELAY BEFORE CRANKING timers will both begin counting at this time, but they each have an independently set value so that the PRE-LUBE pump can be set to run prior to the cranking only or thru the cranking cycle or until some point in time after the engine starts. If an optional pressure setpoint is going to be used to terminate the PRE-LUBE operation, this can be done by using a secondary control setpoint on oil pressure assigned to one of the discrete control outputs. In system STATE 1, while these timers are running, all class A setpoints are being monitored and if any of these monitored points fault, the auto start sequence will be terminated and the cause of the fault displayed, returning the unit to system STATE 0 on the sequence chart. If no faults are present during system STATE 1, the DELAY BEFORE CRANKING timer continues to count until the selected value is reached. In system STATE 1 of the sequence the system turns on the power supply OUTPUT #4, the PRE-LUBE output. This allows for the activation of an electrically controlled pre-lube pump for a programmed time period of 0 to 999 seconds prior to and/or during cranking. The use of an appropriate warning device which can be used to alert any personnel near the engine of the forthcoming start attempt is strongly recommended. This warning device (flashing lights or horn) can be activated by the PRE-LUBE output directly or thru the use of auxiliary relay contacts.

STATE 2: BEGIN CRANKING

When cranking begins the system is at STATE 2 on the sequence chart. After a user programmed time delay, adjustable from 0 to 999 seconds and set when programming the unit; the engine cranking will begin. At the point of cranking, the Class B and Class C timers begin counting their programmed lock out delay before arming values. The reason that these counters are not started until this point in system STATE 2 is to maintain a constant lockout time from engine start before arming regardless of the time required for cranking. This allows the Class B and Class C setpoints to behave in the same manner and use the same timer values for both AUTO START and MANUAL starting sequences. The CRANKING motor is controlled via power supply OUTPUT #3, which would typically be used to control a solenoid valve or power relay connected to the starting device.

STATE 3: PURGE 1 NO FUEL NO IGNITION

As the engine cranking begins, the DE-3000 system implements the engine purge cycle. The first engine purge cycle consists of a programmed roll time, 0 to 10 seconds (5 second typical), without fuel or ignition.

STATE 4: PURGE 2 NO FUEL WITH IGNITION

The second engine purge cycle is an additional programmed time from 0 to 10 seconds with the ignition firing and no fuel being supplied while still cranking.

STATE 5: STARTING FUEL AND IGNITION ON

After a total purge time of ten seconds, both ignition and fuel have been enabled via outputs #1 and #2 of the power supply module and the engine should begin running.

STATE 6: ENGINE STARTED

As the engine speed increases, the user programmable CRANK DISCONNECT speed switch function will automatically disable the starter at the selected RPM by de-energizing OUTPUT #3. This is the beginning of system STATE 6 on the sequence chart. If the crank disconnect RPM is not reached within a user programmed time period after the cranking output is energized (15 to 99 seconds), an OVERCRANK FAULT will be generated. The OVERCRANK FAULT will turn off the fuel and ignition and disable the starter until a new AUTO START command is received returning the system to STATE 0. If the DE-3000 is set up for Multi-Start, then a delay timer will begin counting down before another start attempt is automatically triggered. Pressing any button on the display during the time between start attempts will cancel Multi-Start, and the DE-3000 will remain in a Stop/Fault mode until it is manually restarted.

STATE 7: ENGINE RUNNING UNLOADED WARMUP

After the engine has started and the cranking device is turned off (system STATE 7 on the sequence chart), the 4-20mA RPM control output to the governor will be at the IDLE speed value. The RPM control output will stay at the IDLE value until a user-programmed delay of 0 to 999 minutes as set by the WARM-UP TIMER is completed.

STATE 8: ENGINE RUNNING PID OUTPUT CONTROL STARTS

After the WARM-UP period ends the sequence begins system STATE 8, the 4-20mA control outputs begin to adjust from their default value according to the programmed configuration. Since the programmed configuration is determined by the USER it is not possible to define a particular behavior of the system as normal. A brief description of a typical application configuration follows, although many other control schemes are equally valid. Refer to FIG. 1, sequence of operation chart.

24.0 OEM ENGINE CONTROL

24.1 OEM ENGINE CONTROL can be used as an engine start-up in applications where the DE-3000 is used to signal instructions to a controller, rather than directly turning on and off fuel and ignition as is done in AUTO START. To use the OEM ENGINE CONTROL option, select and configure it in the PC terminal program under the Program Global Variables screen. The four output modules on the power supply board should be configured as follows for OEM ENGINE CONTROL: Out 1 for Driven Equipment Ready (DER), Out 2 for Start/Run Signal, Out 3 Auxiliary if necessary, Out 4 for Pre/Post Lube. OEM ENGINE CONTROL begins its sequence when an auto start command is sent to the DE-3000. The various programmable timers for each module on the power supply board output are shown below.

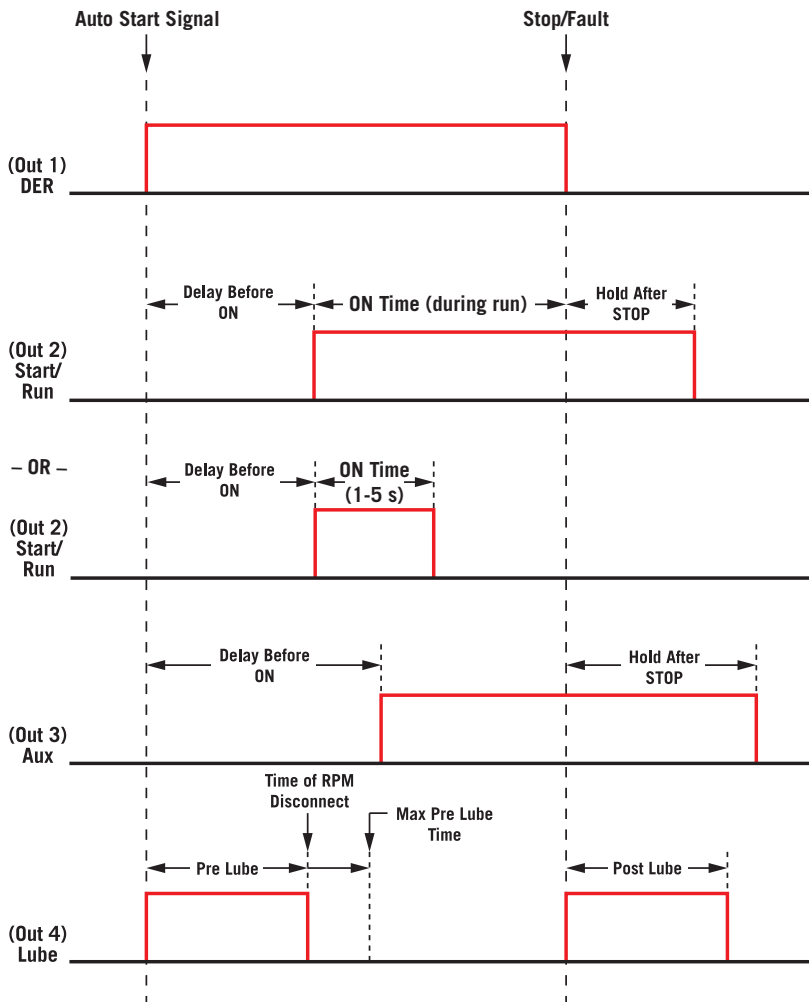

- 24.2 The OEM ENGINE CONTROL sequence must begin from an engine stopped condition. When a DE has been configured for OEM ENGINE CONTROL and an auto start is signaled by grounding the 'R' terminal on the terminal board, Lube turns ON, the Crank/Multi-Start disconnect timer starts, and the 'Delay before ON' timers for the Start/Run Signal and the Auxiliary output begin counting down. DER remains ON from the time the auto start signal is sent to the DE-3000 until a manual stop or fault occurs. All class A setpoints are monitored and class B and C timers begin once the auto start signal is received.
- 24.3 Once the engine speed has surpassed a specified RPM, the Lube will turn OFF. This Pre Lube Disconnect must occur before the Pre Lube time expires. If it does not, a PRELUBE FAULT will occur and all four outputs will turn OFF and the sequence will terminate.
- 24.4 The engine speed must also reach a speed above the Crank/Multi-Start disconnect RPM before its corresponding timer expires. If it does not, an OVERCRANK FAULT will be generated and all outputs will turn OFF. If the DE-3000 is set up for Multi-Start, then a delay timer will begin counting down before another start attempt is automatically triggered. Pressing any button on the display during the time between start attempts will cancel Multi-Start, and the DE-3000 will remain in a Stop/Fault mode until it is manually restarted.
- 24.5 The Auxiliary and Start/Run Signal turn ON once their corresponding 'Delay before ON' timers expire. The Auxiliary output will remain on for the entirety of the DE's run time, but the Start/Run Signal can be programmed to turn OFF after 1-5 seconds, or just remain ON during the DE's run time.
- 24.6 When a manual stop or fault occurs, DER turns OFF and Lube turns ON. The Auxiliary and Start/Run Signal (if still ON) remain ON after a stop or fault for their respective 'Hold after Stop' times and then turn OFF. Lube turns OFF after its programmed Post Lube time.

25.0 SELECTING A CONTROL STRATEGY

- 25.1 The control strategy best suited to a particular application varies widely. The following information is offered as a set of general guidelines and definitions. Each application should be evaluated by qualified personnel familiar with the actual operating conditions.
- 25.2 The DE-3000 controller can be programmed to regulate compressor throughput by controlling both capacity and engine speed. In any particular application, it may be desirable to control the total compressor throughput using only one of these.
- 25.3 The RPM control of the engine can be done using one of the analog control outputs of the DE-3000 as a 4-20mA current loop which can be connected directly to an electronic governor. If a governor requiring a pneumatic setpoint (3-15psi) is used then the 4-20mA output is connected to an appropriate I/P transducer.
- 25.4 The CAPACITY control output of the DE-3000 is available in two formats, to drive the most common actuating systems. The first output format is an industry-standard 4-20mA current loop used for continuously adjustable (sometimes referred to as linear) control. The 4-20mA. output would typically be used to interface to a pneumatically controlled bypass valve. A second set of capacity control outputs is brought out of the controller in a digital format (discrete transistors). The digital or discrete outputs consist of two transistors which switch on to ground and are designed to drive relay coils or pilot duty solenoid valves. One switch is labeled DIGITAL OUT 1 and energizes to LOAD the compressor the other is labeled DIGITAL OUT 2 and energizes to UNLOAD the compressor.

The typical application on reciprocating compressors would be to use the 4-20mA. CAPACITY output to connect to an appropriate I/P transducer which then connects via tubing to the actuator input of a pneumatically controlled external bypass valve.

On some screw compressors utilizing an internal stepless bypass, a spring-bi-

ased turn valve, or slide valve, the 4-20mA. CAPACITY output can be connected to an appropriate I/P transducer which then connects via tubing to the actuator in order to move the valve

The second set of capacity control outputs is brought out of the controller in a digital format (discrete transistors). The digital or discrete outputs consist of two transistors which switch on to ground and are designed to drive relay coils or pilot duty solenoid valves. One switch is labeled DIGITAL OUT 1 and energizes to LOAD the compressor the other is labeled DIGITAL OUT 2 and energizes to UNLOAD the compressor. When used with the hydraulically positioned slide valve on a screw compressor application, these outputs are typically connected to a three-way solenoid valve. On reciprocating compressors, the digital outputs can be used to actuate a motor controlled bypass valve via relay contacts which energize the motor to move in the open or close directions.

- 25.5 The PRIMARY control input should be selected on the basis of the prevailing operating conditions at the compressor site as well as considerations of loading fluctuations, etc. Some basic approaches to compressor load control are listed below:

Suction pressure control

By holding suction pressure at a nearly constant value, a large number of limited flow rate wells can be kept productive with minimal upset conditions. Usually this approach is characterized as a relatively limited supply, or a low flow rate supply of gas, at a given site. This approach may also be required as part of various reclamation or vapor recovery programs. This is an inverse acting relationship — increasing the throughput of the compressor causes the suction pressure to decrease.

Discharge pressure control

By holding discharge pressure at a constant value, a trunk line feeding a larger compressor, or pipeline system, permits a supply of gas to be delivered at a rate approximately equal to the rate at which it is to be consumed. The amount of gas being compressed is not necessarily limited by its availability at the compressor site, but by how much has been consumed by the destination site. This is a direct acting relationship — increasing the throughput of the compressor causes the suction pressure to increase.

Engine Manifold pressure control

By adjusting the compressor throughput on the basis of engine manifold pressure, compressed gas is being produced at a rate that is determined by the horsepower available at the site. This approach would be used where there is plenty of gas available at the wellhead and all of it that is produced can be sold or consumed. In this situation, the only limitation on compressor loading is how much work the engine can do without subjecting it or the compressor to an overload. In the case of electric motor driven compressors, a motor current sensor or kW sensor works in the same manner as the engine manifold pressure sensor on a gas engine.

- 25.6 When programming the DE-3000 system, the basic relationship of the Primary Control Inputs (A1, A2, S1), Primary Control Outputs (AO1 and AO2), and Output Actuators needs to be defined.

The relationship between a Primary Control Input and Primary Control Output is defined as either direct or inverse acting. direct acting means that to increase the value of the Primary Control Input, the throughput of the compressor is increased. Inverse acting means that to increase the value of the Primary Control Input, the compressor load must be decreased. In the examples of common control approaches given; discharge pressure and engine manifold pressure or motor amps are direct acting. Suction pressure is an example of a control parameter that is inverse acting. In order to increase suction pressure the compressor throughput must be reduced.

- 25.7 The secondary control setpoint options have been modified to add more flexibility as detailed below.

• **INHIBIT AN OUTPUT INCREASE**

The output of one or more of the control loops can be limited in the increasing direction only, while allowing the assigned out-put to freely decrease.

- **INHIBIT AN OUTPUT DECREASE**

The output of one or more of the control loops can be limited in the decreasing direction only, while allowing the assigned output to freely increase.

- **FORCE AN OUTPUT INCREASE**

The output of one or more of the control loops can be forced to increase even if the primary control loop requires a different action.

- **FORCE AN OUTPUT DECREASE**

The output of one or more of the control loops can be forced to decrease even if the primary control loop requires a different action.

In addition to these actions being assignable to the analog inputs, they are also assignable to the analog outputs (AO1, AO2). This allows for the output of one control loop to interact with the other according to a programmed priority. For example, the output of loop #2 can be inhibited until a certain output value of Loop #1 is reached.

In addition to defining the input/output relationship, the relationship of the control output value to the actuator must also be defined as either direct or inverse acting. As in the case of the control input/output relationship, the direct acting output mechanism is one where an increase in current from the controller causes an increase in load on the compressor. An inverse operating actuator is one where the current is decreased to increase the load on the compressor.

26.0 CALIBRATION OF TRANSDUCERS

- Connect the computer cable from the computer to the DB9 port #1 on the back of DE-3000 display module.
- Using the DE-3000 software resident on the CDROM, open the DE-3000 program. Then click on the CALIBRATE button at the top of the screen.
- Select the number of channel to be calibrated.
- The sensor selection box will show either the default value or the past calibrated value depending the firmware version of the DE-3000.
- Under the CALIBRATION SETPOINT section is a box that reads CURRENT DATA. This is the actual information being displayed on the DE-3000 Display.
- On the Terminal Board connect a voltmeter between the (+) and (-) transducer output terminals for the channel being calibrated.
- Apply the desired minimum pressure or temperature to the transducer being calibrated. Next take note of the voltage being measured on the voltmeter, this voltage is to be entered in the LOW SENSOR VOLTAGE box. Then click the ACCEPT key to enter the new low value.
- Increase the pressure or temperature to the desired high reading of the transducer being calibrated. Again take note of the voltage being measured and enter the measured voltage in the HIGH SENSOR VOLTAGE box and hit accept.

Calibration of that channel is complete.

27.0 PASSWORD PROTECTION

27.1 PASSWORD FOR THE MENU

The DE-3000 contains a numerical password, which, when correct, allows the user to modify key parameters. The range of the password may be any number between 0 and 999. The same password for the MENU also applies for the NEXT key. When the MENU key is pressed, the following screen appears:

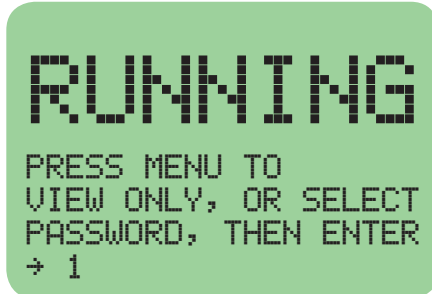

```
RUNNING
PRESS MENU TO
VIEW ONLY, OR SELECT
PASSWORD, THEN ENTER
➔ 1
```

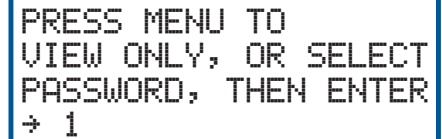

```
PRESS MENU TO
VIEW ONLY, OR SELECT
PASSWORD, THEN ENTER
➔ 1
```

Press the MENU key again to view menu parameters and not modify them. Press the UP, UP/TENS, DOWN, DOWN/TENS keys to modify the value to the correct password value. If the password is not correct, the display shows the first MENU screen but does not allow for values to be modified. If the password is correct, the following MENU will appear:

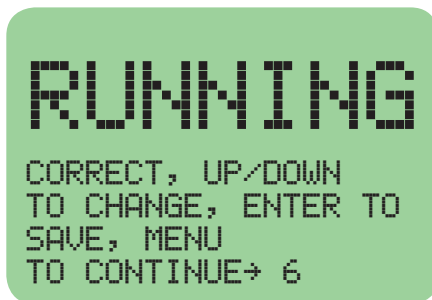

```
RUNNING
CORRECT, UP/DOWN
TO CHANGE, ENTER TO
SAVE, MENU
TO CONTINUE➔ 6
```

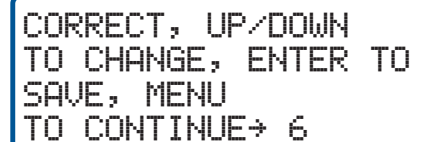

```
CORRECT, UP/DOWN
TO CHANGE, ENTER TO
SAVE, MENU
TO CONTINUE➔ 6
```

The password may be changed at this point, or the user can continue to the MENU to view and modify menu parameters. Use the UP, UP/TENS, DOWN, DOWN/TENS key to modify the new password value and press ENTER to save the new password.

27.2 PASSWORD FOR THE NEXT KEY (PID PARAMETERS)

The DE-3000 contains a numerical password, when correct, which allows the user to modify PID parameters. The range of the password may be any number between 0 and 999. When the NEXT key is pressed, the screen below appears.

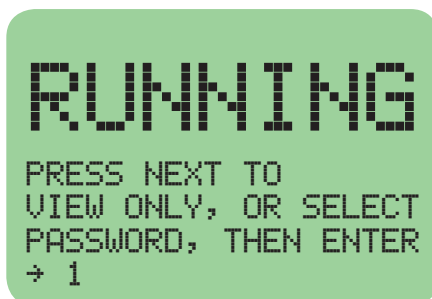

```
RUNNING
PRESS NEXT TO
VIEW ONLY, OR SELECT
PASSWORD, THEN ENTER
➔ 1
```

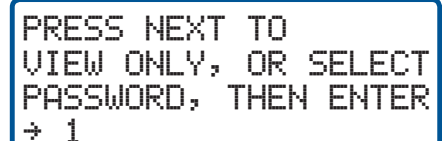

```
PRESS NEXT TO
VIEW ONLY, OR SELECT
PASSWORD, THEN ENTER
➔ 1
```

Press the NEXT key again to view PID parameters and not modify them. Press the UP, UP/TENS, DOWN, DOWN/TENS keys to modify the value to the correct password value. If the password is not correct, the display shows the first PID screen but does not allow for values to be modified. If the password is correct, the following MENU will appear:

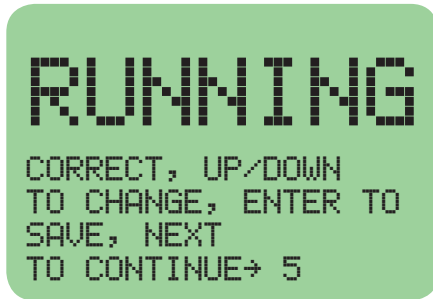

The password may be changed at this point, or the user can continue to the NEXT to view and modify PID parameters. Use the UP, UP/TENS, DOWN, DOWN/TENS keys to modify the new password value and press ENTER to save the new password.

CORRECT, UP/DOWN
TO CHANGE, ENTER TO
SAVE, NEXT
TO CONTINUE→ 5

NOTE: IF THE PASSWORD IS LOST OR FORGOTTEN, CONTACT ALTRONIC PERSONNEL FOR DIRECTIONS ON RESETTING THE PASSWORD. FOR THOSE NOT WISHING PASSWORD PROTECTION, LEAVE THE PASSWORD AT '1'.

28.0 USB VIRTUAL COM PORT DRIVER INSTALLATION

Windows™ Operating Systems Supported: XP SP3, 7, 8, and 10

28.1 The Installation of the DE-3XXX Terminal Program has a routine that also installs the “FTDI Chip CDM Drivers” that are updated for use with the latest versions of Windows as noted in the title. The normal installation of the Terminal Program will show these third party installation screens as shown starting in 28.2. Once installed, the drivers should automatically be accessed when the Terminal Program USB connection is made to the DE-3XXX.

If it should be necessary, you can uninstall the Virtual USB port drivers by following the directions in section 29.

In addition, you can “Update the Drivers” if you have acquired a newer FTDI Chip CDM Driver, by following this same procedure.

Before installation:

- Administrator access to the computer is required for this installation.
- Make sure the device is NOT connected to the PC before proceeding.

28.2 (Skip this step if you are installing the DE-3XXX Terminal Program or follow this step if you are reinstalling FTDI Chip CDM Drivers).

If you are not signed in to the computer on an administrator account, open the CDM vX.XX.XX WHQL Certified file, right-click on it and select ‘Run as administrator’. When asked if you would like it to make changes to the computer, click ‘Yes’. This file can be found at:

C:\Altronic LLC\Altronic DE-3000 Terminal Program Vx.x\CDMxxxxx_SETUP

28.3 When the FTDI driver package opens, the following screen will appear. Click 'Extract'.

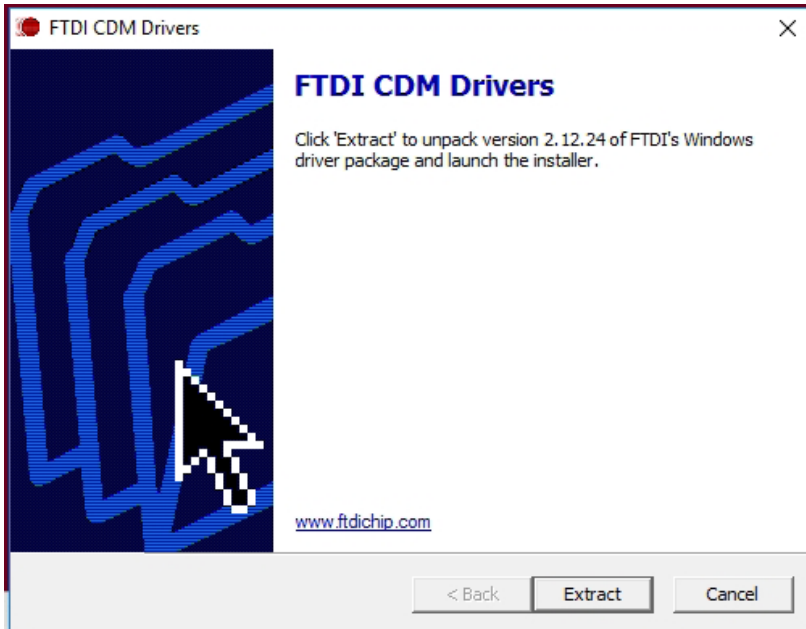

28.4 Once extracted, the Installation Wizard will begin running. Click 'Next' to install the drivers.

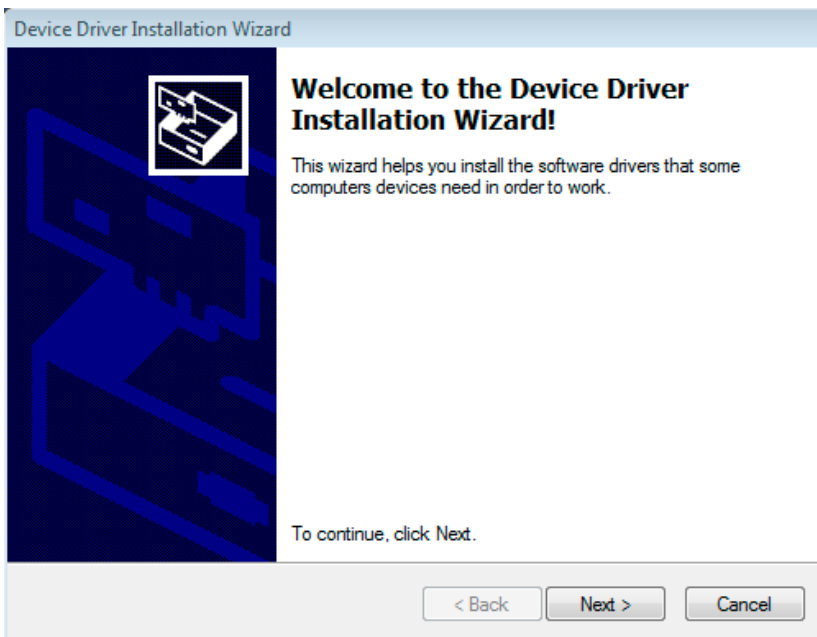

- 28.5 When the installation completes, ensure that the drivers were successfully installed and ready to use as noted in the screen below. The device is now able to connect to the PC and be configured using the terminal program.

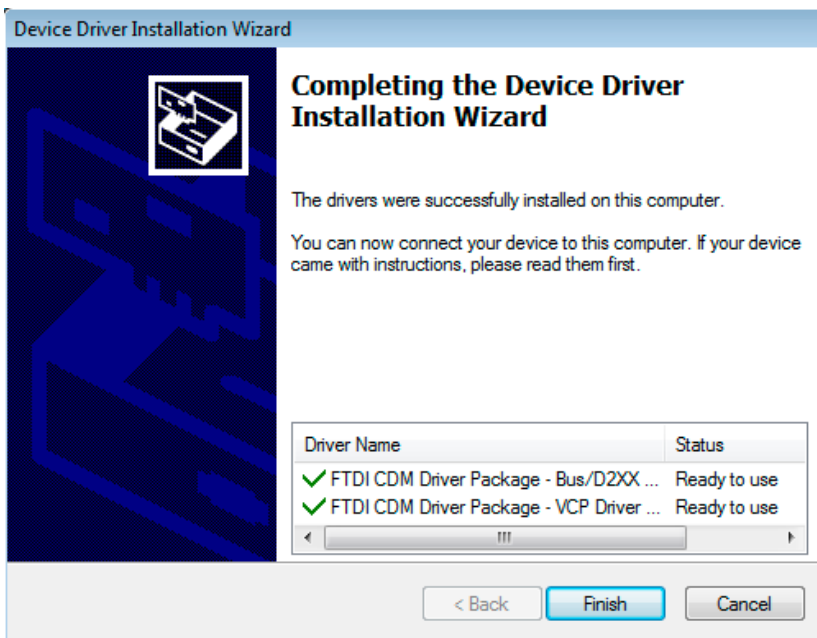

- 28.6 Click "Finish" to complete the installation.

29.0 USB VIRTUAL COM PORT DRIVER UNINSTALLATION

29.1 Administrator access to the computer is required for this uninstallation.

29.2 The FTDI utility CDM Uninstaller

<http://www.ftdichip.com/Support/Utilities.htm#CDMUninstaller> can be used to remove FTDI drivers from the Windows 7, 8, 10 PC. The utility is available on the FTDI web site.

29.3 Alternately devices can be removed using the Device Manager by simply right clicking on the mouse and selecting “Uninstall”. This will delete the associated registry entries for that device only. Windows™ 7, 8, and 10 provide an automatic method to delete driver files via a check box to “Delete the driver software for this device” on the uninstall dialog box.

29.3.1 The COM port driver should be uninstalled before the bus driver. If the bus is removed first, the COM port will no longer appear in the Device Manager.

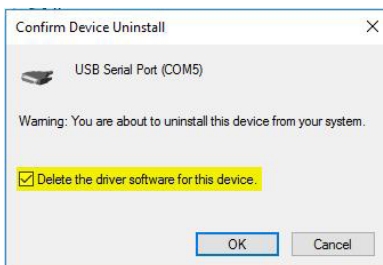
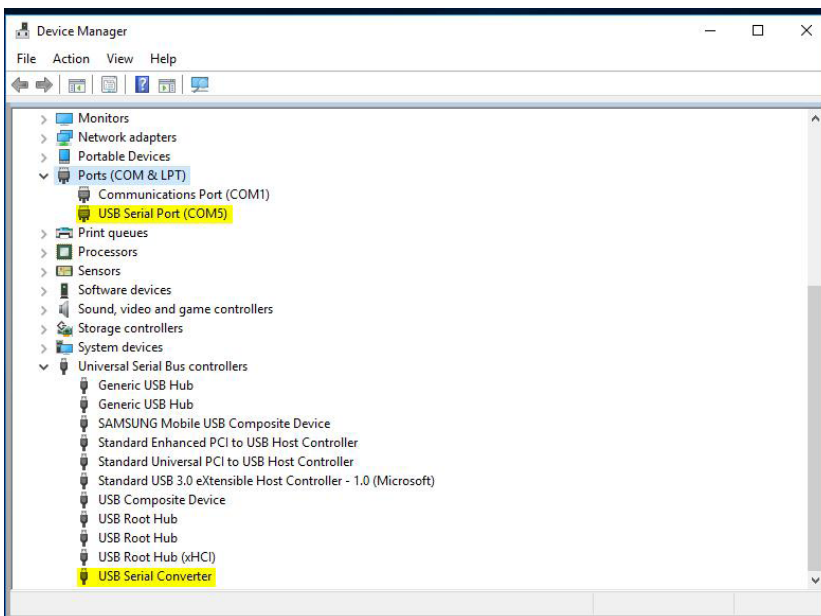

This stage is done twice. Once for the device under Ports (COM & LPT) and once for the device under Universal Serial Bus Controllers.

29.4 Windows XP does not have this check box, so driver files and OEM INF and PNF files must be removed manually or by using a custom application.

30.0 PROGRAMMING INSTRUCTIONS

30.1 DESCRIPTION

The Altronic DE series terminal program operates from a standard PC and permits the operator to configure the DE system. A data sheet can be printed showing, in table form, the global, channel, home screen and view process screen data. The operator can monitor an existing installation and access system data in Monitor mode. This data can be accessed locally or remotely via a modem.

Altronic program required:

DE-3000.TP Terminal program, Altronic DE-3000 System

Available from <http://www.altronic-llc.com/catalog-downloads.shtml>

Hardware required:

Computer: IBM-compatible PC, Windows™ XP, 7, 8, 10, hard drive (32MB of free disk space required), internet access, 1 RS-232 serial or USB port, SVGA graphics (800x600 or greater preferred) with color monitor. If remote monitoring is used, a PC modem, 9600 baud or greater is needed.

Printer: Selections on screen for windows printer

Port: RS-232, USB

Modem: 9600 baud (or greater) required for monitor function

30.2 INSTALLATION

The program can be downloaded from Altronic's website at <http://www.altronic-llc.com/catalog-downloads.shtml>. A minimum of 32MB of free disk space is required. Additional disk space will be required if the remote datalog database function is used. The space required will be dependent on the size of the working database.

Installation of the Altronic Terminal program requires "Administrative Privilege". Once Setup_DE-3000-Vxx.exe has been downloaded from the Altronic Website, run the file as Administrator. For Windows XP, right click on the Setup_DE-3000-Vxx.exe file, select "Run As...", select the Administrator account and provide the password. For Windows 7, 8, and 10, right click on the Setup_DE-3000-Vxx.exe file, select "Run As Administrator" to start the installation.

The default folder is C:\Altronic LLC\Altronic DE-3000 Terminal Program Vx.x. Reboot the system after the installation is complete. Run the Program from the Start Button, All Programs, Altronic LLC, DE-3000, and select the DE-3000 menu selection.

30.3 PROGRAM OPERATION

Most menu options are also available from the graphic toolbar.

When the program first runs, you must input a user name along with the selection of the PC serial or USB port to which the DE-3000 will connect for programming. All screens have a status bar at the bottom that will let the user know the current status of each operation. Version information along with general Help can be found under the Help menu. At the login screen, if you are not connected to the DE-3000, or the firmware date on the DE-3000 could not be determined, you must select version 1.X or version 2.X of the terminal program. Version 1.X corresponds to .pg6/tr6 configuration files, and version 2.X corresponds to .pg7/tr7 configuration files.

IMPORTANT: Version 2.X contains features such as OEM Engine Control, Linear/Ramp Control, Multi-Start, Cool-Down, and Lube Monitoring, which are not compatible with DE-3000 firmware that predates 2014. Therefore, version 2.X should only be selected if you are certain that your DE-3000 system (both the display and terminal boards) is configured with firmware from 2014 onward, and uses the 128x64 multi-color graphics display.

CONFIGURE: Allows system configuration in one of three ways:

- create a new application from a default file
- upload an existing program from another DE device of the same part no.
- load a previously saved disk file

The user can then edit any parameter.

DOWNLOAD: A previously saved disk file can be downloaded directly to the DE device.

PRINT: The user can print out the data from a saved disk file.

MONITOR: The user can remotely monitor a DE system.

HOST MODE: PC modem monitors for an incoming call from the DE system.

EXIT: Terminates the DE terminal program.

30.4 Configure DE-3000 Device

- A. Create New - loads the DEFAULT.PGx file into the program.
- B. Retrieve from DE-3x00 - uploads the data from another DE-3x00 and loads it into the program.
- C. Retrieve from File - loads the user selected file into the program. A file selection box will appear. Double click on the file you want to use. Version 2.X provides file-conversion support for .PG6 files. If there exists a saved .PG6 configuration file (with the corresponding .T1tr6 and .T2tr6 files where applicable), the terminal program will convert the 1.X configuration into an equivalent 2.X one. Once it has been converted, it is possible to utilize any new features included only in the 2.X version and then save the file as a .PG7. **THE DE-3000 STILL CAN ONLY BE PROGRAMMED THROUGH THE 2.X TERMINAL PROGRAM IF ALL TERMINAL AND DISPLAY BOARD FIRMWARE FOR THE DEVICE IS DATED 2014 OR LATER.**
- D. Cancel - cancels the operation and returns the user to the main form.

Program Global Variables

- A. Annunciator Node Number - used in remote communications. Valid numbers are 1-99.
- B. Timer Intervals - all timers have valid values of 1-999. The class C timer is in minutes; all other timers are in seconds. Version 2.X allows channels to be configured for cool-down functionality. The timer for cool-down channels is set here.
- C. Output module selection:
 1. NO - normally open
 2. NC - normally closed
 3. Ign/Fuel Valve Module - special module
- D. Assign to Stop Function - this determines if the output will trip when STOP is selected.
- E. Data Logging Selections:
 1. Header - this 30 character field will be the heading of the datalog report. It can consist of alphanumeric ASCII characters along with # % + - . /
 2. Data Logging Interval - time between event logging. Valid values are 1-999 minutes.
 3. Continue Data Logging After a Shutdown - Yes/No selects whether data logging will continue after a shutdown occurs.
- F. OEM Engine Control (Version 2.X) and AutoStart - enable and configure either the OEM Engine control or Autostart sequences and the Multi-Start functionality (Version 2.X)

- G. Terminal Board Tab
 - 1. Identification - board type and firmware date
 - 2. Solenoid Pulse Control - enable digital outputs for solenoid pulse control
 - a. unload pulse on stop/fault - time (seconds) that solenoid will unload after a stop or fault
 - 3. Pulses per Revolution - for magnetic pickup on speed input
 - 4. Integrated Timer Output (Version 2.X) - set up digital output to turn ON at startup and remain ON after a stop/fault for specified amount of time (minutes)
 - 5. Alarm - enable digital output for alarm when channels use this digital output for a control assignment
 - 6. Service Meter Expiration - set up this digital output to turn on and remain on when a service meter expires
 - 7. Fault Condition - set up this digital output to turn on and remain on when a fault occurs
- H. Save Global Data - saves current selections and loads the next form.
- I. Cancel - cancels current operation and returns user to the main form.

Program Channels form appears

- A. Channel Number - select the channel number from the drop down list that you would like to program.
- B. User Label - this is a 20 character label that defines the channel operation. It can consist of alphanumeric ASCII characters along with # % + - . /
- C. SAVE Button - saves the current channel label to the default label file, so it can be selected from the drop down list.
- D. Input Type - Channels 1-60 can be a discrete or analog device.
- E. Input Class - selects whether input class is type A, B or C.
- F. Time in seconds or minutes.
 - 1. Input Class A - no time defined, instant trip. The time box is disabled.
 - 2. Input Class B - time may be defined from 1-999 seconds.
 - 3. Input Class C - global class C time displayed in minutes. Time box is disabled.
- G. Output Assignments - check any or all outputs to trip when a discrete input switches out of normal state or when an analog input exceeds the control range.
- H. Previous Screen - closes current form and loads Program Global Variables form.
- I. Previous Channel - decrements selected channel.
- J. Next Channel - increments selected channel.
- K. Save Channel Data - saves current selections and loads the next form.
- L. Cancel - cancels current operation, returns user to main form.
- M. Differential - two consecutive analog input channels can be set up for differential measurement when this box is checked. The first channel selected for differential will still measure that channel's individual input and evaluate the safety and control setpoints for that input. The second channel will measure the difference between the two channels' inputs (1st channel minus 2nd channel) and evaluate the safety and control setpoints based on the differential measurement.
- N. Cool-down - input class B or C channels can be set up for the cool-down function when this box is checked (Version 2.X only)
- O. Lube No-Flow - Channels 27 and 28 can be configured for lube monitoring when an analog input is selected and this box is checked (Version 2.X). Doing so sets up the sensor type on the screen and allows a maximum time between pulses to be entered.

Program Control Values form appears

- A. PID - setup control parameters for corresponding analog output number
- B. Solenoid Pulse Control - input channel 3 can control digital outputs 1 and 2 to be used for solenoid pulse control
- C. Cascade RPM/LOAD Control - configure A02 for Cascade Control
- D. Linear/Ramp Control - (Version 2.X only) configure A02 for Linear/Ramp Control. The DE-3000 will create a linear relationship between the value of Channel 1 and the output current. It is up to the user to map an accurate RPM value to the min and max output limit.

Program Home Screen Values form appears

- A. Select the corresponding channel numbers to display the serial information on the display home screen. Valid values are 1–60.
- B. Previous Screen - closes current form and loads Program Channel Values form.
- C. Save Labels - saves current selections and loads the next form.
- D. Cancel - cancels current operation, returns user to main form.

Program View Process Screen form appears

- A. Select the corresponding channel numbers to display the serial information for the display view process screens. Valid values are 1–60.
- B. Previous Screen - closes current form and loads Program Home Screen Values form.
- C. Save Labels - saves current selections, loads the next form.
- D. Cancel - cancels current operation, returns user to main form.

Display Configuration form appears

- A. Previous Screen - closes current form and loads Program View Process Screens form.
- B. Program DE-3x00 - this takes the current data set and saves it to the download.PGx file, then programs the DE device and verifies that programming was completed successfully.
- C. Save to File - this creates a PGx file. This file can be used at a later date to program the unit, or used for reference purposes.
- D. Print Data - the user can print out the chart on this form for reference purposes.
- E. Cancel - cancels current operation, returns user to main form.

30.5 DOWNLOAD

This allows the user to select any PGx file that they'd like to use to program the DE-3x00. The DE-3x00 is then programmed and verified that programming was completed successfully.

30.6 PRINT

The user can select a PGx file to print out. The data grid will be loaded with the file data. PRINT will print the data, CANCEL will exit and return the user to the main form.

30.7 MONITOR

In this main screen, the text box will display data communications from the PC to the DE system via a modem. If the terminal is connected to the device, the current Home Screen and View Process screen values will be displayed. If no connection is established, the values in these boxes will be N.C. (no connection)

30.8 MONITOR DE-3x00

- A. Connect to DE-3x00 - initiates the call to establish communications with the DE system.
- B. Hangup - terminates a call.

30.9 DATA LOGGING

The user can display data from the requested datalog record.

- A. Retrieve Datalog Record

30.10 CONFIGURE DE-3x00 MODEM

This allows the user to configure the modem connected to the DE system. The modem must be connected to the selected serial port of the PC when this option is used. After programming is completed, the modem then has to be reconnected to the DE-3x00.

- A. Send/Edit Configuration

EXIT - exits Monitor function and returns user to main form.

30.11 HOST MODE

PC modem monitors for an incoming call from the DE system. If a first-out fault occurs and the DE-3x00 calls the PC where the host mode is enabled, the results will be displayed in this text window.

30.12 EXIT

This ends program execution and returns the user to the Windows™ operating system.

GLOSSARY:

ACTUATOR	Electromagnetic devices which convert electric current to linear or rotary motion. This motion may then be used to control equipment directly, an electromechanical actuator, or it can be used to regulate a gas or liquid pressure as in a current to pressure converter (I/P).
ANALOG INPUT	An input which accepts voltage signals between 0 and 5 volts. These signals are converted by the DE-3000 to engineering units and compared by the microprocessor to user programmed safety shutdown and control setpoints.
ANALOG OUTPUT	An output which provides a current between 4-20mA to external devices to control the compressor. These outputs can be used to interface directly to electrical actuators or connected to I/P transducers mechanical actuators.
CAPACITY CONTROL	The capacity control of the compressor is accomplished by reducing the volume of gas moved per compressor cycle. 100% capacity is the full rated volume of gas compressed per machine cycle. Capacity control can be done on both reciprocating and screw compressors using various techniques.
COMPRESSOR CYCLE	A compressor cycle is a full rotation of the compressor drive shaft. A turn of the screw on a screw compressor or a revolution of the crankshaft on a reciprocating compressor.
CONTROL SETPOINTS	These are setpoints programmed by the user which are within the normal operating range of the equipment and are used to optimize the function of the equipment. Control setpoints may also be used to implement corrective actions to prevent overstress of components or to notify personnel of potential problems before they become severe enough to cause a shutdown.
CRANK DISCONNECT	The RPM setting at which output #3 of the power supply will be de-energized. This will de-energize the starting device.
CRANKING DELAY	The time after the auto start command before cranking will begin. Allows for pre-lube function and starting warning to personnel. Power supply output #4 is normally energized during this time. See PRE-LUBE TIME.
CURRENT STEP LIMIT	The current step limit is a maximum value that the analog output will be allowed to change from one control cycle to another. The current step limit is used to prevent rapid or erratic control action of the actuator even under transient conditions or with a poorly tuned control system. A limit of about 2mA or about 10% of the output range is reasonable default value.
CYCLE TIME	The time taken between adjustments of the PRIMARY CONTROL loop. The longer the cycle time selected the less responsive the control output is to variations in the controlled parameter. The cycle time is adjustable from 1 to 999 seconds.
DEADBAND	The controller deadband defines a user programmed value both above and below the setpoint for which no corrective action will be taken. Deadband is used to improve control stability by holding the controller output constant in the presence of "noise" or small transient errors on the input.
DIRECT ACTING	When describing control or actuator functions, direct acting is used to identify relationships where the controller must increase its output to cause an increase in the variable.

GLOSSARY:

INVERSE ACTING	When describing control or actuator functions, inverse acting is used to identify relationships where the controller must decrease its output to cause an increase in the variable.
MAXIMUM RPM	The maximum RPM setting is the highest governor setpoint value which will be sent by the controller in an attempt to satisfy the primary control setpoint. The maximum running RPM.
MINIMUM RPM	The minimum RPM is the governor setpoint value which will be sent by the controller after the warmup delay time has been fulfilled. The minimum RPM is the speed which must be seen by the controller to allow loading of the compressor to begin.
OVERCRANK TIME	The maximum time that the starting device will remain energized by output #3 before the starting attempt is considered failed. If an overcrank occurs, the crank disconnect RPM is not reached before the overcrank time, then an overcrank fault has occurred.
PRE-LUBE TIME	A user programmed time for which output #4 will remain ON after the beginning of an AUTO START sequence. Normally used for control of a pre-lube pump and to signal that a starting attempt is about to begin.
PRIMARY CONTROL	The primary control is a closed loop based upon an input value selected from channels 01, 02, or 03. The throughput of the compressor is adjusted by the controller to maintain this setpoint.
PROPORTIONAL BAND	The proportional band is used to tune the response of the controller to the characteristic behavior of the equipment being controlled. Proportional band is the inverse of gain expressed as a percentage. A proportional band setting of 10% is equal to a gain setting 10, a proportional band setting of 20% is equal to a gain of 5, etc. The smaller the proportional band setting the greater the controller response to a difference between the measured value and the setpoint.
RPM CHANGE/CYCLE	The maximum RPM change per cycle is used to limit the rate at which the controller output to the governor will be allowed to change. This limit is used to avoid rapid speed changes during transient conditions.
SAFETY SHUTDOWN	Safety shutdown setpoints are those which cause the protected equipment to be shutdown or stopped in order to protect the equipment and or the operating personnel. These setpoints must be selected to be outside the range of normal operation.
SECONDARY CONTROL	Secondary or supplemental control functions are accomplished by sensing user programmed control setpoints. LOAD INHIBIT or FORCE UNLOAD strategies, as well as alarms or corrective actions can be implemented.
THROUGHPUT	The total volume of gas per unit of time moved by the compressor. Throughput is varied by both speed and capacity adjustments made by the controller.
WARMUP DELAY	The warmup delay time is user programmable from 0 to 99 minutes. This allows for the engine/compressor to run unloaded for this time delay as part of the auto start sequence. The engine speed output to the governor will be held at the idle RPM value during the warmup delay.

MODBUS ADDRESS LIST:

ADDRESS	DESCRIPTION OF FUNCTION
40001	NULL
40002	Hourmeter; range from 0-65535
40003	NULL
40004	STATUS FAULT (01-60) FOR FAULT CHANNEL 01-60 S01 = 151, S02 = 152, Overcrank = 165, serial fault = 166 00 = STOP, 254= timers active, 255 = running
40005	Output status BIT0 = OUT1, BIT1 = OUT2, BIT2 = OUT3, BIT3=OUT4
40006	Fault Status, 0=NA, 1=LOW FAULT, 2=HIGH FAULT
40020	Digital output status for terminal board #01
40021	Digital output status for terminal board #02
40030 — 40069	The ASCII characters of what is contained on the display of the DE-3000. The upper part of the register displays the first character followed by the low part of the register as the next character. This may be used for MMI/MIDAS applications.
40080	Writable register for the keypad input. Use function 6 to perform the write. Section 18.16 describes the values for each key press. This register, along with 40030-40069, may be used in conjunction with a MMI/Red Lion to press keys on the keypad.
40090 — 40149	40090 = channel 01, 40091 = channel 02...
40200	Writable register for PID setpoint #1
40201	Writable register for PID setpoint #2
40202	Indicates the time remaining for the test timer. The value is (-1) if not in test mode.
40250	RPM; range from 0 - 9999 (S01)
40251	RPM; range from 0 - 9999 (S02)
40255	Analog output in percent (A01)
40256	Analog output in percent (A02)
40257	Analog output in percent (A03)
40258	Analog output in percent (A04)
40300 — 40449	Decimal point location for channel 001—150, range from 0 to 3. 0 = no decimal place, 1 = 1 decimal place. Etc.

The following registers valid for display firmware version 2019 or greater.

40007	MIRROR IMAGE OF 40004 FOR CONTIGUOUS OPERATION WITH REGISTER 40006
40190	Control Setpoint, Solenoid Pulse Control
40191	Cycle Time, Solenoid Pulse Control
40192	Proportional Control, Solenoid Pulse Control
40193	Dead Band, Solenoid Pulse Control
40194	A01, PID CONTROLS, Proportional Band (P)
40195	A01, PID CONTROLS, Integral (I)
40196	A01, PID CONTROLS, Differential (D)
40197	A02, PID CONTROLS, Proportional Band (P)
40198	A02, PID CONTROLS, Integral (I)
40199	A02, PID CONTROLS, Differential (D)
40200	Control Setpoint, A01
40201	Control Setpoint, A02
40205	A03, PID CONTROLS, Proportional Band (P)
40206	A03, PID CONTROLS, Integral (I)
40207	A03, PID CONTROLS, Differential (D)
40208	A04, PID CONTROLS, Proportional Band (P)
40209	A04, PID CONTROLS, Integral (I)
40210	A04, PID CONTROLS, Differential (D)
40230	Linear Ramp Control, Low Variable
40231	Linear Ramp Control, High Variable
40232	Linear Ramp Control, Low mA current. 0 = 4mA, 4095 = 20mA
40233	Linear Ramp Control, High mA current. 0 = 4mA, 4095 = 20mA
40238	A01, PID CONTROLS, Deadband
40239	A02, PID CONTROLS, Deadband
40244	A03, PID CONTROLS, Deadband
40245	A04, PID CONTROLS, Deadband

Channel	Low Safety Shutdown	High Safety Shutdown	Low Control Setpoint	High Control Setpoint
1	41025	41026	41027	41028
2	41029	41030	41031	41032
3	41033	41034	41035	41036
4	41037	41038	41039	41040
5	41041	41042	41043	41044
6	41045	41046	41047	41048
7	41049	41050	41051	41052
8	41053	41054	41055	41056
9	41057	41058	41059	41060
10	41061	41062	41063	41064

Channel	Low Safety Shutdown	High Safety Shutdown	Low Control Setpoint	High Control Setpoint
11	41065	41066	41067	41068
12	41069	41070	41071	41072
13	41073	41074	41075	41076
14	41077	41078	41079	41080
15	41081	41082	41083	41084
16	41085	41086	41087	41088
17	41089	41090	41091	41092
18	41093	41094	41095	41096
19	41097	41098	41099	41100
20	41101	41102	41103	41104
21	41105	41106	41107	41108
22	41109	41110	41111	41112
23	41113	41114	41115	41116
24	41117	41118	41119	41120
25	41121	41122	41123	41124
26	41125	41126	41127	41128
27	41129	41130	41131	41132
28	41133	41134	41135	41136
29	41137	41138	41139	41140
30	41141	41142	41143	41144
31	41149	41150	41151	41152
32	41153	41154	41155	41156
33	41157	41158	41159	41160
34	41161	41162	41163	41164
35	41165	41166	41167	41168
36	41169	41170	41171	41172
37	41173	41174	41175	41176
38	41177	41178	41179	41180
39	41181	41182	41183	41184
40	41185	41186	41187	41188
41	41189	41190	41191	41192
42	41193	41194	41195	41196
43	41197	41198	41199	41200
44	41201	41202	41203	41204
45	41205	41206	41207	41208
46	41209	41210	41211	41212
47	41213	41214	41215	41216
48	41217	41218	41219	41220
49	41221	41222	41223	41224
50	41225	41226	41227	41228
51	41229	41230	41231	41232
52	41233	41234	41235	41236
53	41237	41238	41239	41240

Channel	Low Safety Shutdown	High Safety Shutdown	Low Control Setpoint	High Control Setpoint
54	41241	41242	41243	41244
55	41245	41246	41247	41248
56	41249	41250	41251	41252
57	41253	41254	41255	41256
58	41257	41258	41259	41260
59	41261	41262	41263	41264
60	41265	41266	41267	41268
S01	41145	41146	41147	41148
S02	41269	41270	41271	41272

Use extreme caution when modifying the ZERO and SPAN adjustments.

CHANNEL	Span Calibration	Zero Calibration
1	42885	42886
2	42889	42890
3	42893	42894
4	42897	42898
5	42901	42902
6	42905	42906
7	42909	42910
8	42913	42914
9	42917	42918
10	42921	42922
11	42925	42926
12	42929	42930
13	42933	42934
14	42937	42938
15	42941	42942
16	42945	42946
17	42949	42950
18	42953	42954
19	42957	42958
20	42961	42962
21	42965	42966
22	42969	42970
23	42973	42974
24	42977	42978
25	42981	42982
26	42985	42986
27	42989	42990
28	42993	42994
29	42997	42998
30	43001	43002
31	43653	43654

CHANNEL	Span Calibration	Zero Calibration
32	43657	43658
33	43661	43662
34	43665	43666
35	43669	43670
36	43673	43674
37	43677	43678
38	43681	43682
39	43685	43686
40	43689	43690
41	43693	43694
42	43697	43698
43	43701	43702
44	43705	43706
45	43709	43710
46	43713	43714
47	43717	43718
48	43721	43722
49	43725	43726
50	43729	43730
51	43733	43734
52	43737	43738
53	43741	43742
54	43745	43746
55	43749	43750
56	43753	43754
57	43757	43758
58	43761	43762
59	43765	43766
60	43769	43770

Please use extreme caution when working with these registers.

CHANNEL	Low Class Time	High Class Time
1	43173	43174
2	43175	43176
3	43177	43178
4	43179	43180
5	43181	43182
6	43183	43184
7	43185	43186
8	43187	43188
9	43189	43190
10	43191	43192
11	43193	43194

Hi 2 bits: Input class (A = '00', B = '01', C = '10')

Low 14 bits: Input class time

Only modify class B times with the range from 10-999 seconds

Bit 14 must be set as well with time.

CHANNEL	Low Class Time	High Class Time
12	43195	43196
13	43197	43198
14	43199	43200
15	43201	43202
16	43203	43204
17	43205	43206
18	43207	43208
19	43209	43210
20	43211	43212
21	43213	43214
22	43215	43216
23	43217	43218
24	43219	43220
25	43221	43222
26	43223	43224
27	43225	43226
28	43227	43228
29	43229	43230
30	43231	43232
31	43941	43942
32	43943	43944
33	43945	43946
34	43947	43948
35	43949	43950
36	43951	43952
37	43953	43954
38	43955	43956
39	43957	43958
40	43959	43960
41	43961	43962
42	43963	43964
43	43965	43966
44	43967	43968
45	43969	43970
46	43971	43972
47	43973	43974
48	43975	43976
49	43977	43978
50	43979	43980
51	43981	43982
52	43983	43984
53	43985	43986
54	43987	43988

CHANNEL	Low Class Time	High Class Time
55	43989	43990
56	43991	43992
57	43993	43994
58	43995	43996
59	43997	43998
60	43999	44000
S1	43233	43233
S2	44001	44002

READ ONLY

READ ONLY

SERVICE METER	Service Meter, High	Service Meter, Low	Reset Value, High	Reset Value, Low
1	44611	44612	44633	44634
2	44613	44614	44635	44636
3	44615	44616	44637	44638
4	44617	44618	44639	44640
5	44619	44620	44641	44642
6	44621	44622	44643	44644
7	44623	44624	44645	44646
8	44625	44626	44647	44648
9	44627	44628	44649	44650
10	44629	44630	44651	44652
11	44631	44632	44653	44654

Please note all the Service Meter values are read only.

HOURMETERS		
MAIN	44655	44656
DRIVER	44657	44658
DRIVEN EQUIPMENT	44659	44660

DRAWINGS SECTION *(Click on a title to go to that drawing)*

- FIG. 1 AUTOSTART SEQUENCE OF OPERATION
- FIG. 2 DE-3000 SYSTEM DIAGRAM
- FIG. 3 DE-3000 TERMINAL MODULE AND POWER SUPPLY MODULE
- FIG. 4 WIRING DIAGRAM: GENERAL HOOK-UP
- FIG. 5 WIRING DIAGRAM: PERSONAL COMPUTER
- FIG. 6 WIRING DIAGRAM: SENSOR AND TRANSDUCER INPUTS
- FIG. 7 WIRING DIAGRAM: CURRENT LOOP OUTPUTS
- FIG. 8 WIRING DIAGRAM: DIGITAL OUTPUT SWITCHES
- FIG. 9 WIRING DIAGRAM: POWER SUPPLY MODULE
- FIG. 10 POWER SUPPLY LED AND OUTPUT MODULE LOCATIONS
- FIG. 11 WIRING DIAGRAM: TACHOMETER INPUT
- FIG. 12 WIRING DIAGRAM: RS-485 COMMUNICATIONS
- FIG. 13 DE-3000 DISPLAY – CONTRAST ADJUSTMENT
- FIG. 14 DRAWING 690 255: INSTALLATION IN DIVISION 1 APPLICATIONS

FIG. 1 AUTOSTART SEQUENCE OF OPERATION

SYSTEM STATE	0 ENGINE STOPPED	1 DELAY BEFORE CRANKING	2 CRANKING	3 PURGE 1	4 PURGE 2	5 STARTING	6 STARTED	7 WARM UP	8 RUNNING
BEGINS ON EVENT SHOWN TO RIGHT	ON A STOP OR A FAULT	AUTO START SIGNAL	AFTER TIMER T1 SECONDS	CRANKING	CRANKING	AFTER TIMER T4 SECONDS	ENGINE FIRING	ENGINE RUNNING AT IDLE RPM	ENGINE RUNNING AT USER SETTING
ENDS	AUTO START SIGNAL	AFTER TIMER T1 SECONDS	AS CRANKING BEGINS	AFTER TIMER T3 SECONDS	AFTER TIMER T4 SECONDS	AFTER TIMER T4 SECONDS + FIRING	CRANKING, MOTOR OFF AT USER SET RPM	AFTER WARM UP TIMER T5 MINUTES	ON A STOP OR A FAULT
OUT 1 FUEL VALVE CONDITION OR STATUS	OFF	OFF	OFF	OFF	OFF	ON	ON	ON	ON
OUT 2 IGNITION CONTROL CONDITION OR STATUS	OFF	OFF	OFF	OFF	ON	ON	ON	ON	ON
OUT 3 CRANKING MOTOR CONDITION OR STATUS	OFF	OFF	ON	ON	ON	ON	ON	OFF LOCKED OUT	OFF LOCKED OUT
OUT 4 LUBE PUMP CONDITION OR STATUS	ON, THEN OFF AFTER POST LUBE	ON FOR TIMER T2 SECONDS, THEN OFF	ON FOR TIMER T2 SECONDS, THEN OFF	ON FOR TIMER T2 SECONDS, THEN OFF	ON FOR TIMER T2 SECONDS, THEN OFF	ON FOR TIMER T2 SECONDS, THEN OFF	ON FOR TIMER T2 SECONDS OR USER OFF RPM	OFF	OFF
ANALOG OUT A01 VALUE	USER DEFAULT VALUE	USER DEFAULT VALUE	USER DEFAULT VALUE	USER DEFAULT VALUE	USER DEFAULT VALUE	USER DEFAULT VALUE	USER DEFAULT VALUE	USER DEFAULT VALUE	PID PER CONTROL SCHEME
ANALOG OUT A02 VALUE	USER DEFAULT VALUE	USER DEFAULT VALUE	USER DEFAULT VALUE	USER DEFAULT VALUE	USER DEFAULT VALUE	USER DEFAULT VALUE	USER DEFAULT VALUE	USER DEFAULT VALUE	PID PER CONTROL SCHEME
CLASS A	ARMED	ARMED	ARMED	ARMED	ARMED	ARMED	ARMED	ARMED	ARMED
CLASS B	DISABLED	DISABLED	DISABLED	DISABLED	DISABLED	DISABLED	DISABLED	ARMED*	ARMED
CLASS C	DISABLED	DISABLED	DISABLED	DISABLED	DISABLED	DISABLED	DISABLED	ARMED**	ARMED
INPUT SETPOINTS AND FAULT SENSOR FUNCTION	FIRST OUT FAULT LOCKED ON TIMERS NOT RUNNING	TIMERS NOT RUNNING	TIMERS NOT RUNNING	TIMERS NOT RUNNING	TIMERS NOT RUNNING	TIMERS NOT RUNNING	B AND C TIMERS BEGIN RUNNING	* B TIMER DELAYS ** AS CLEARED OR "C" TIMER MET	

NOTE: AUXILIARY FUNCTIONS force and inhibit as assigned, and auxiliary outputs 3 through 7 are always active

FIG. 2 DE-3000 SYSTEM DIAGRAM

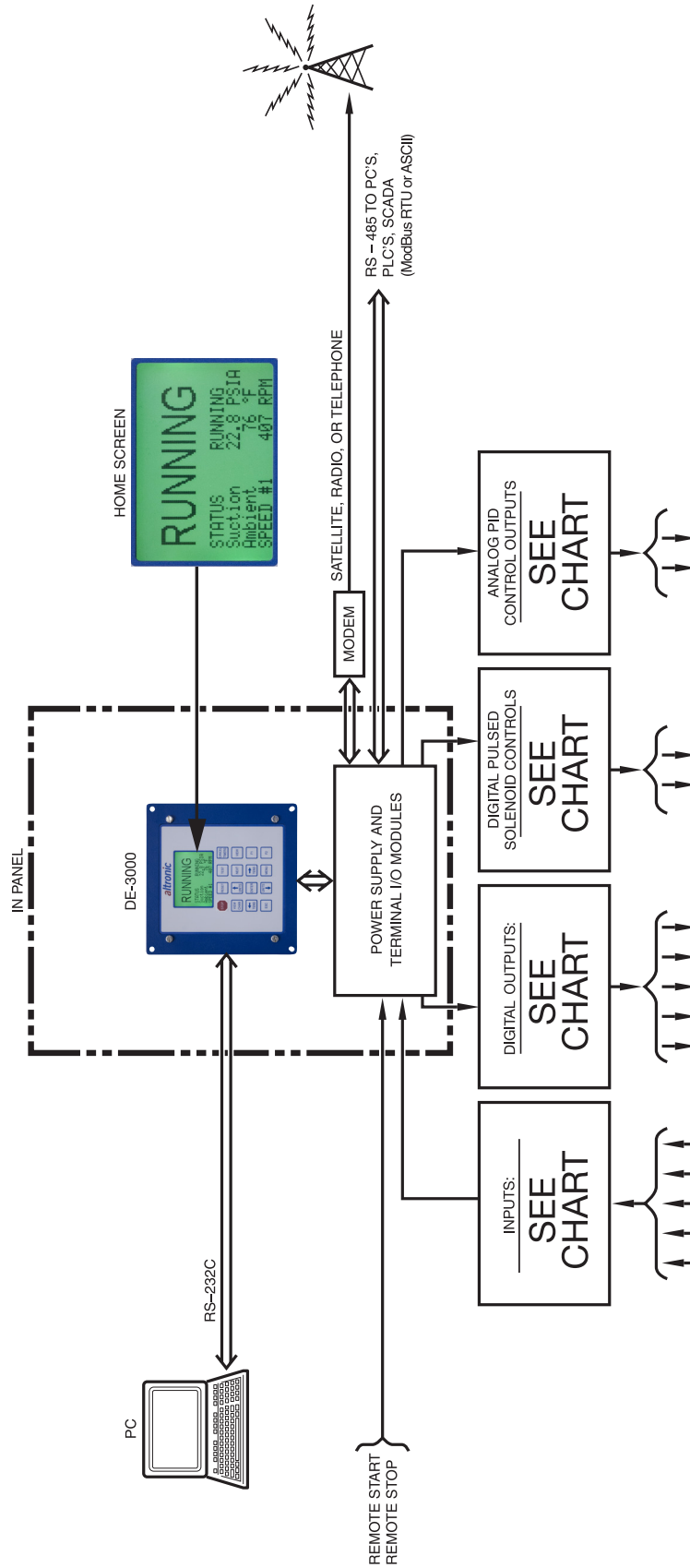

FIG. 3 DE-3000 TERMINAL MODULE AND POWER SUPPLY MODULE

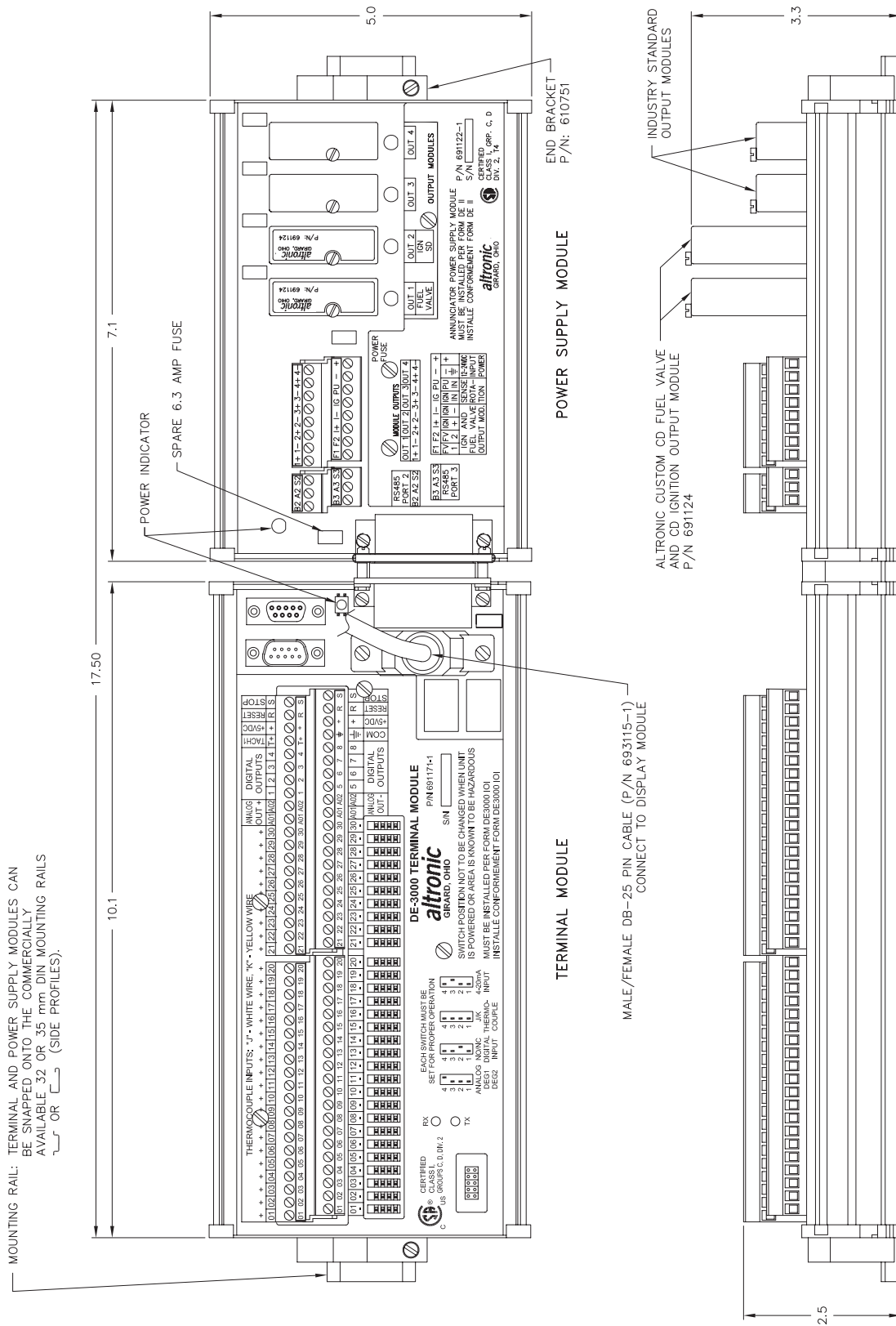

FIG. 4 WIRING DIAGRAM: GENERAL HOOK-UP

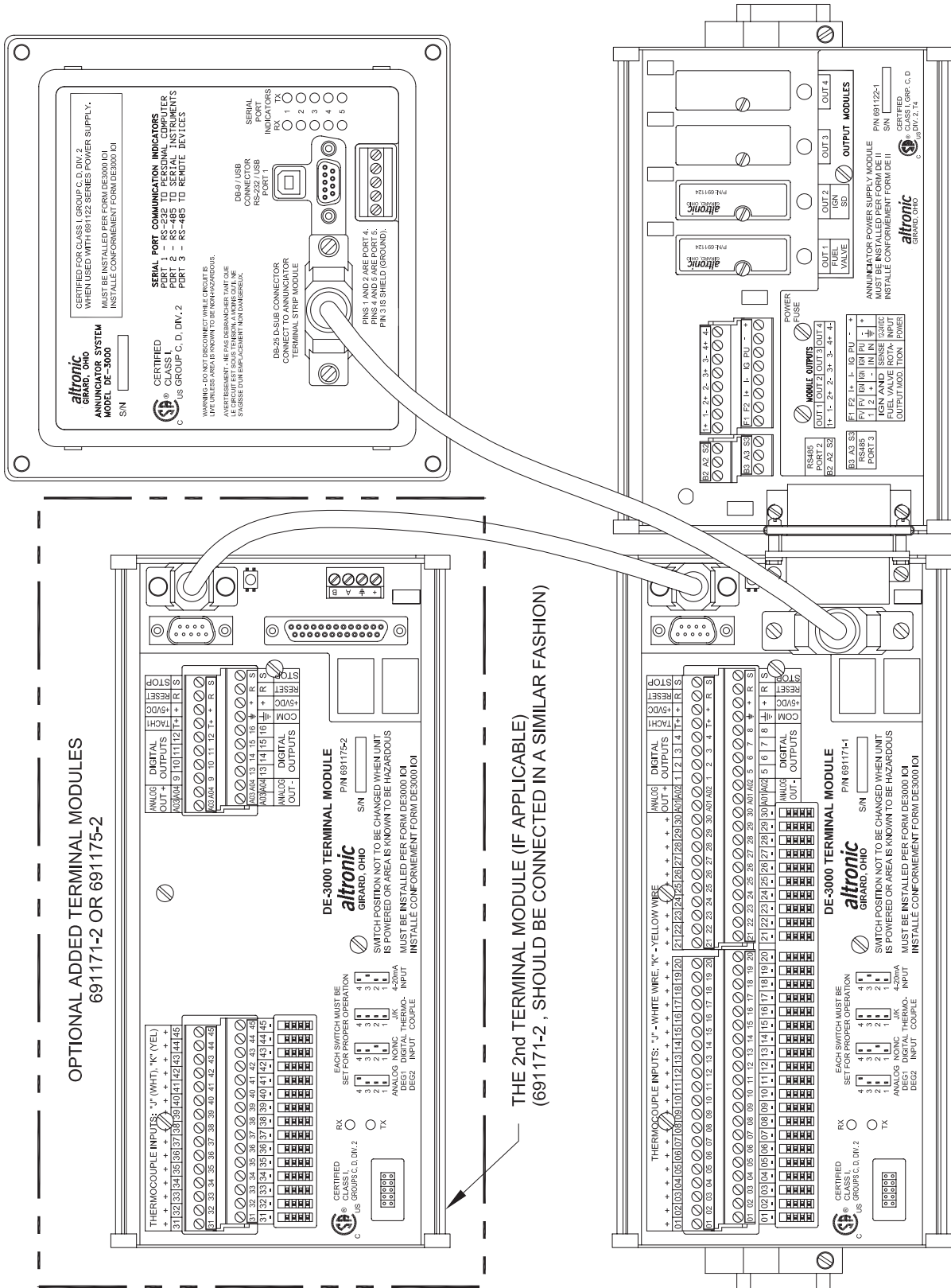
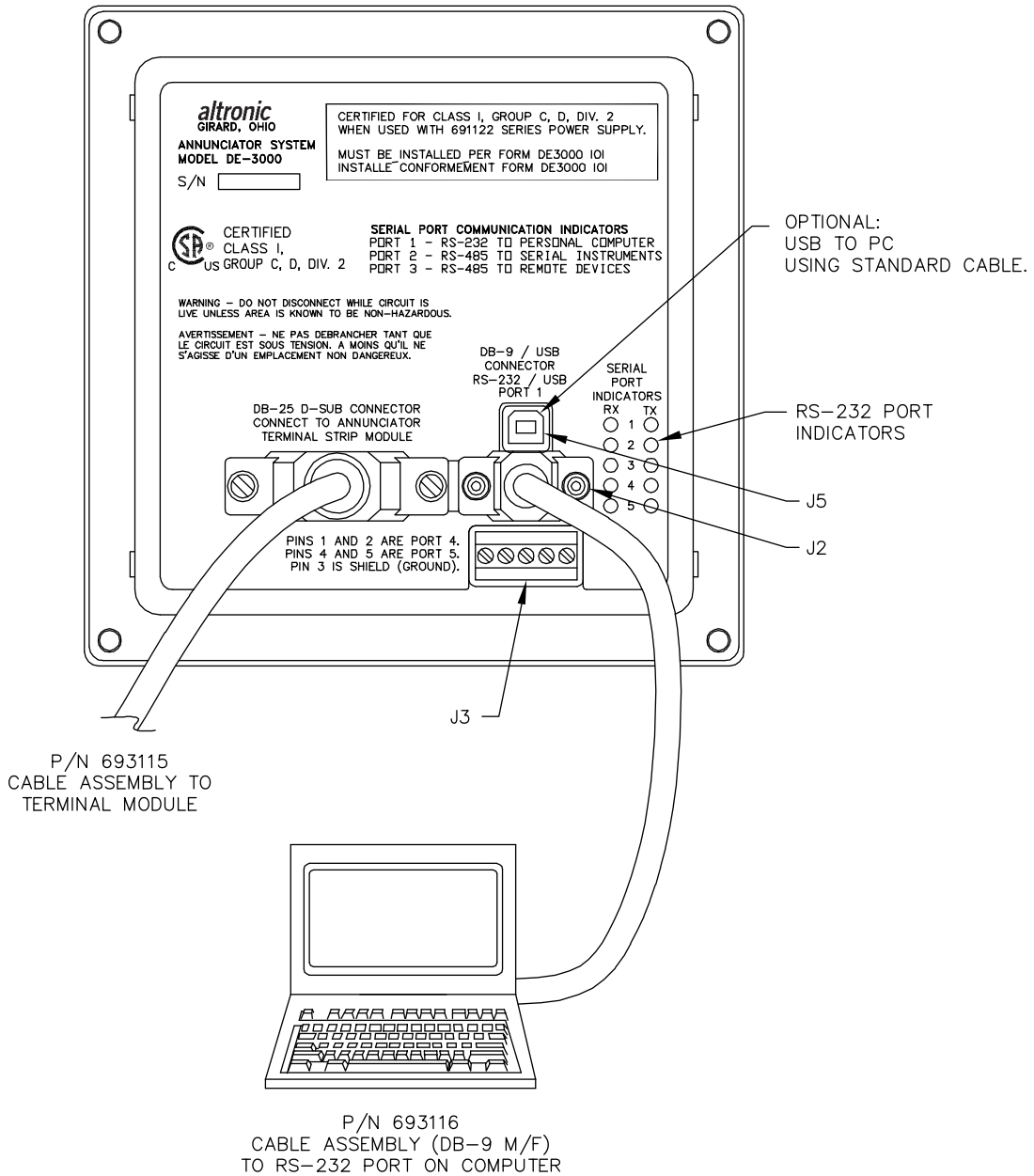
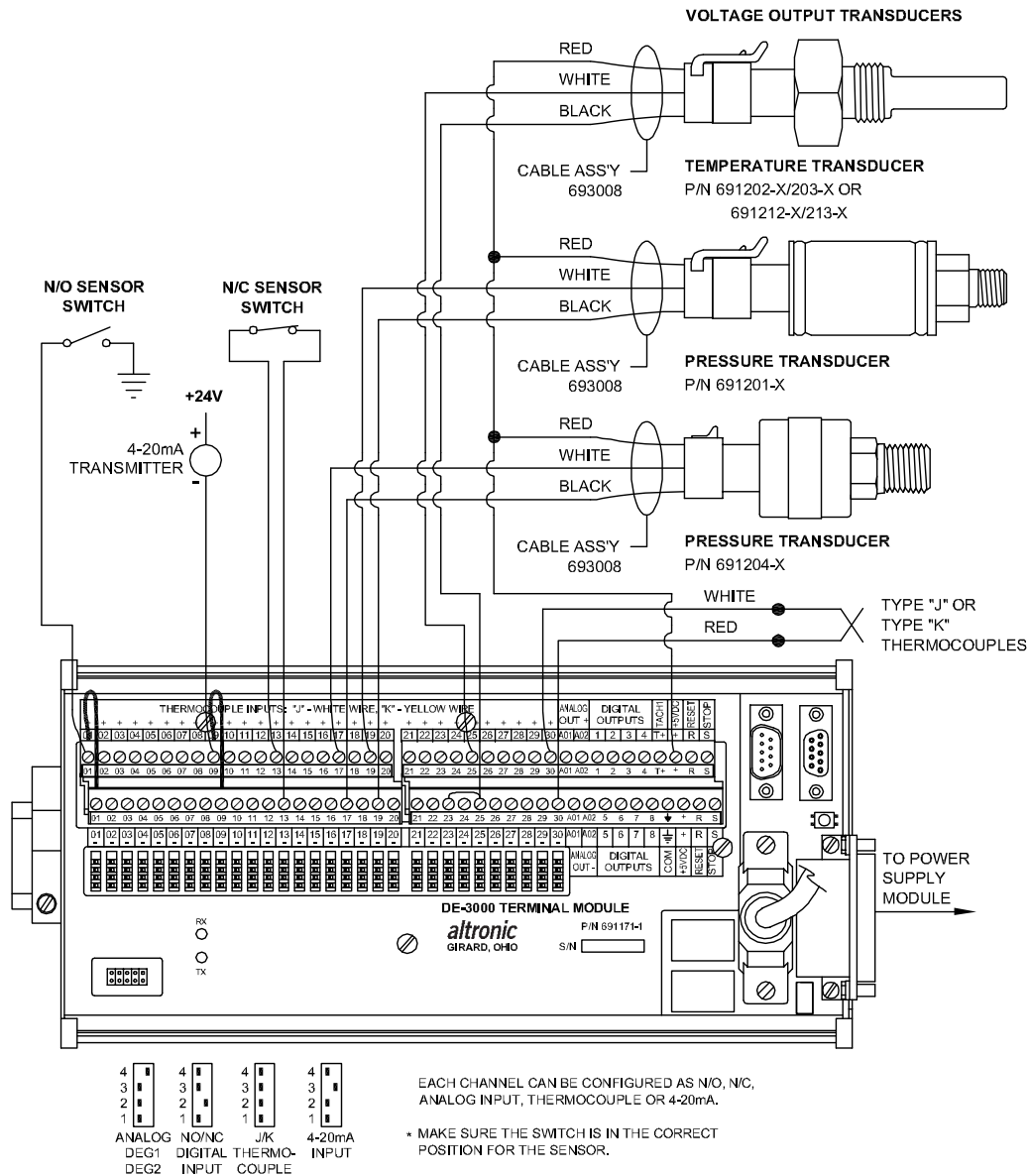

FIG. 5 WIRING DIAGRAM: PERSONAL COMPUTER



NOTE: FOR DIV. 1 APPLICATIONS UTILIZING THE 691350-1 POWER SUPPLY. J2, J3,
AND J5 ARE NOT TO BE USED UNLESS AREA KNOWN TO BE NON-HAZARDOUS.

FIG. 6 WIRING DIAGRAM: SENSOR AND TRANSDUCER INPUTS



NOTE:

1. N/O SENSOR SWITCH MUST HAVE JUMPER IN PLACE BETWEEN TOP ROW AND BOTTOM ROW OF TERMINAL BLOCK. POWER SUPPLY MINUS AND SENSOR GROUND MUST BOTH BE COMMON.
2. N/C SENSOR SWITCH, REMOVE JUMPER AND PLACE SWITCH WIRES, ONE IN TOP ROW OTHER IN BOTTOM ROW.
3. ALL UNUSED INPUTS MUST HAVE JUMPER WIRE IN PLACE.
4. REMOTE RESET (R) AND REMOTE STOP (S) ARE WIRED SAME AS OTHER SWITCHES. STOP OVERRIDES RESET.
5. THE +5VDC INTERNAL SUPPLY OUTPUT IS LIMITED TO 500 mA MAXIMUM, IF THIS SUPPLY EXITS THE PANEL, IT MUST BE FUSED WITH A 0.5 AMPERE FUSE. BOTH +5VDC TERMINALS ARE ELECTRICALLY CONNECTED TOGETHER. TWO TERMINALS ARE PROVIDED FOR WIRING CONVENIENCE ONLY.
6. 24 VOLT POWER TO 4-20mA TRANSMITTERS MUST HAVE A COMMON GROUND TO POWER SUPPLY FOR TERMINAL MODULES.
7. FOR DIV. 1 APPLICATIONS UTILIZING THE 691350-1 POWER SUPPLY. TOTAL ALLOWABLE INDUCTANCE OF ALL CONNECTED SENSORS AND WIRING TO BE 6.34 μ H AND TOTAL CAPACITANCE TO BE 288.1 μ FD OR LESS.

FIG. 7 WIRING DIAGRAM: CURRENT LOOP OUTPUTS

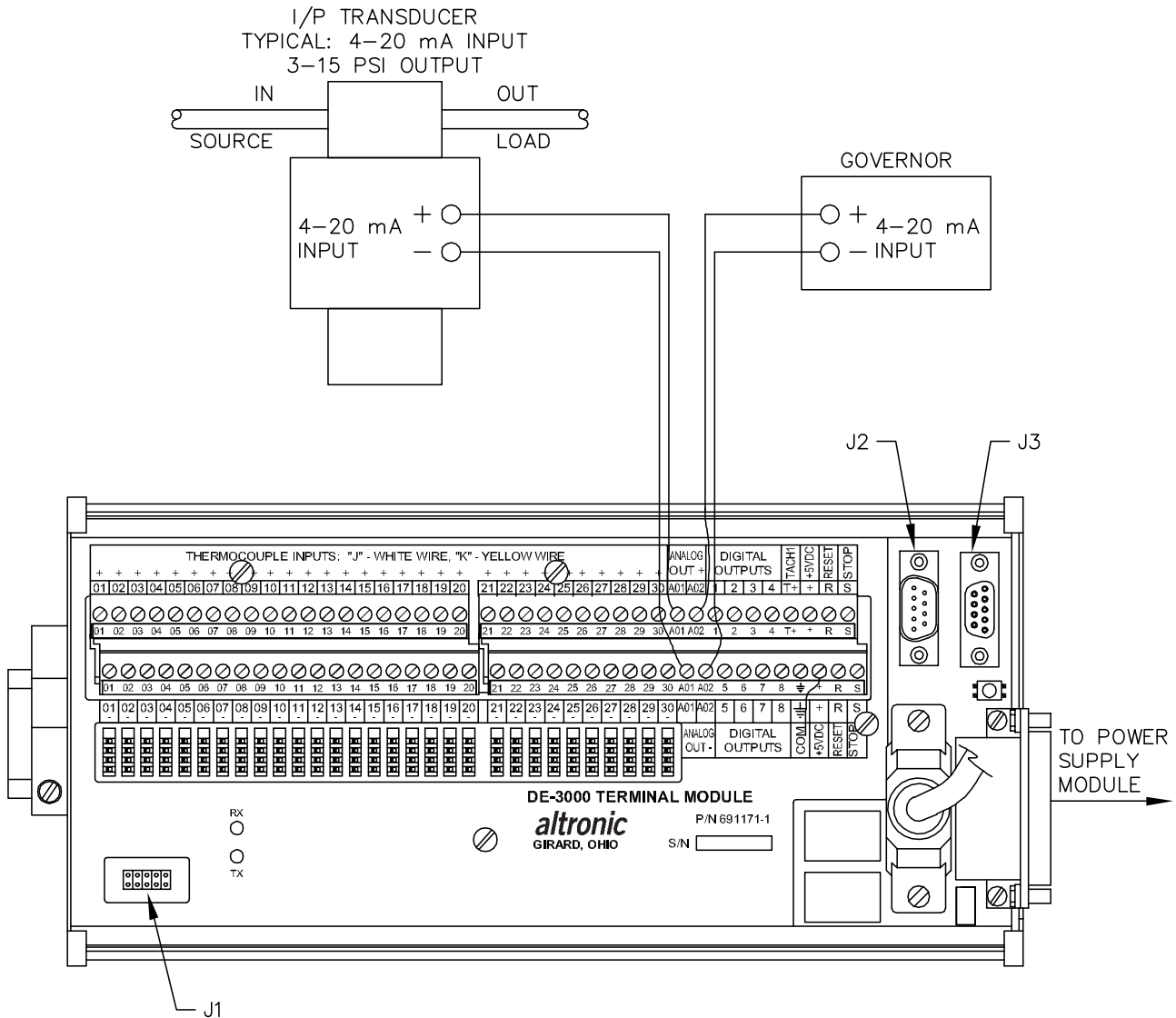

NOTES:

1. CURRENT LOOP OUTPUT 1 IS TYPICALLY USED TO CONTROL CAPACITY CONTROL. CURRENT LOOP OUTPUT 2 IS TYPICALLY USED AS A GOVERNOR SPEED SETPOINT FOR SPEED CONTROL.
2. FOLLOW MANUFACTURERS RECOMMENDATIONS FOR MOUNTING AND MECHANICAL HOOK-UP OF CURRENT LOOP CONVERTERS.
3. FOR DIV. 1 APPLICATIONS UTILIZING THE 691350-1 POWER SUPPLY. J1, J2, AND J3 ARE NOT TO BE USED UNLESS AREA KNOWN TO BE NON-HAZARDOUS.

FIG. 8 WIRING DIAGRAM: DIGITAL OUTPUT SWITCHES

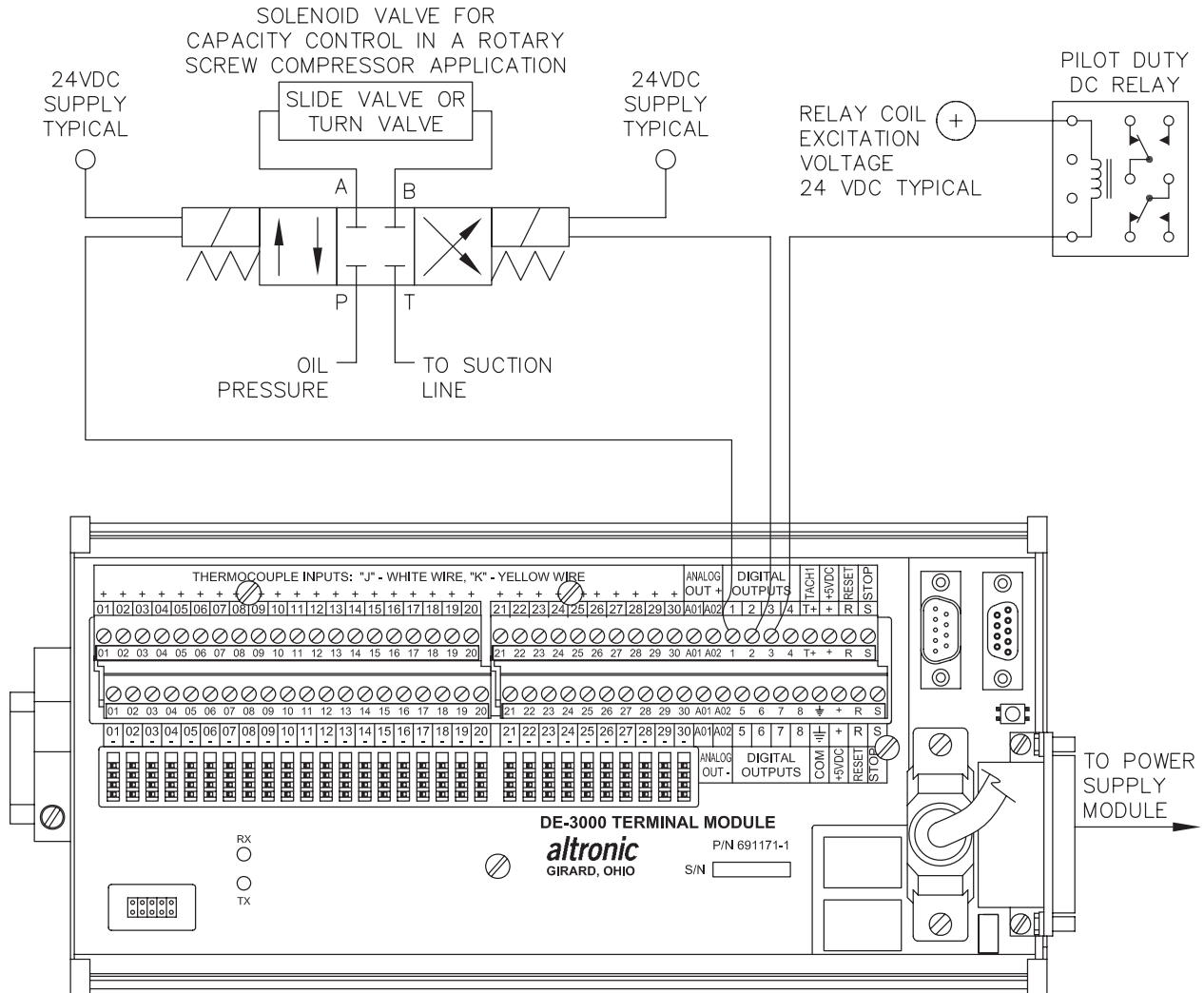

NOTES:

1. SOLENOID VALVE: 4 WAY SOLENOID CLOSED-CENTER TYPE. BOTH PORTS BLOCKED IN CENTER POSITION WITH BOTH SOLENOIDS DE-ENERGIZED.
2. DIGITAL OUTPUT 1 ENERGIZED TO LOAD, DIGITAL OUTPUT 2 ENERGIZED TO UNLOAD.
3. THIS DIAGRAM SHOWS TYPICAL CONNECTIONS. FOLLOW MANUFACTURERS RECOMMENDATIONS FOR COMPLETE SYSTEM COMPONENTS AND HOOK-UP.
4. USE PILOT DUTY RELAYS CONNECTED TO DIGITAL OUTPUTS TO CONTROL.
 - OIL OR WATER COOLERS
 - OIL TEMPERATURE CONTROL VALVE
 - OIL HEATERS
 - PRELUBE PUMPS
 - AND OTHER AUXILIARY EQUIPMENT

FIG. 9 WIRING DIAGRAM: POWER SUPPLY MODULE

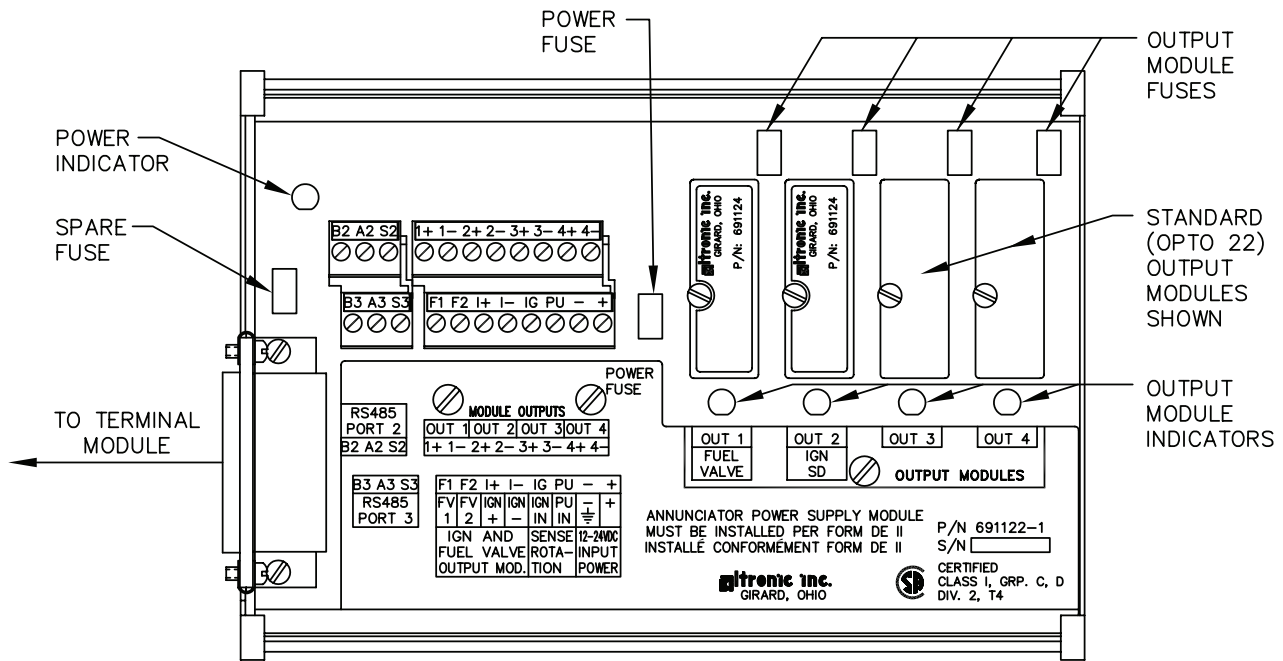

FUSES: FUSES ARE REPLACEABLE 6.3 AMP, P/N 601653.

OUTPUT MODULES: 691124 – THIS CUSTOM MODULE HAS TWO USES: CONNECTION TO A MURPHY FUEL VALVE AND DIRECTLY GROUNDING A C.D. IGNITION SYSTEM.
 – USE IN POSITION OUT 1 TO CONNECT TO A C.D. IGNITION TYPE MURPHY FUEL VALVE.
 – USE IN POSITION OUT 2 TO DIRECTLY GROUND–OUT (STOP) A C.D. IGNITION SYSTEM.

691125 – THIS STANDARD MODULE IS RATED FOR 5–48 Vdc, 5.0 A. AND MAY BE USED IN ANY OF THE FOUR OUTPUT SLOTS OUT 1 THROUGH OUT 4.

691056 – THIS STANDARD MODULE IS RATED FOR 5–60 Vdc, 2.0 A. AND MAY BE USED IN ANY OF THE FOUR OUTPUT SLOTS OUT 1 THROUGH OUT 4.

691066 – THIS STANDARD MODULE IS RATED FOR 5–200 Vdc, 0.67 A. AND MAY BE USED IN ANY OF THE FOUR OUTPUT SLOTS OUT 1 THROUGH OUT 4.

691065 – THIS STANDARD MODULE IS RATED FOR 24–280 Vac, 2.0 A. AND MAY BE USED IN ANY OF THE FOUR OUTPUT SLOTS OUT 1 THROUGH OUT 4.

NOTE: OTHER INDUSTRY STANDARD 0.6 INCH MODULES MAY BE USED AS REQUIRED.

LED OPERATION: – THE POWER LED INDICATOR LIGHTS WHEN POWER IS APPLIED TO THE SYSTEM.
 – FOR THE NORMALLY CLOSED CONFIGURED OUTPUT MODULES (ENERGIZED FOR RUN), THE LED WILL BE ON IN THE NORMAL RUN STATE AND OFF FOR A FAULT CONDITION.
 – FOR THE NORMALLY OPEN CONFIGURED OUTPUT MODULES, THE LED WILL BE OFF IN THE NORMAL RUN STATE AND TURN ON FOR A FAULT CONDITION.
 – FOR THE ALTRONIC OUTPUT MODULES P/N 691124, THE LED WILL BE ON IN THE NORMAL RUN STATE AND OFF FOR A FAULT CONDITION.

FIG. 10 POWER SUPPLY LED AND OUTPUT MODULE LOCATIONS

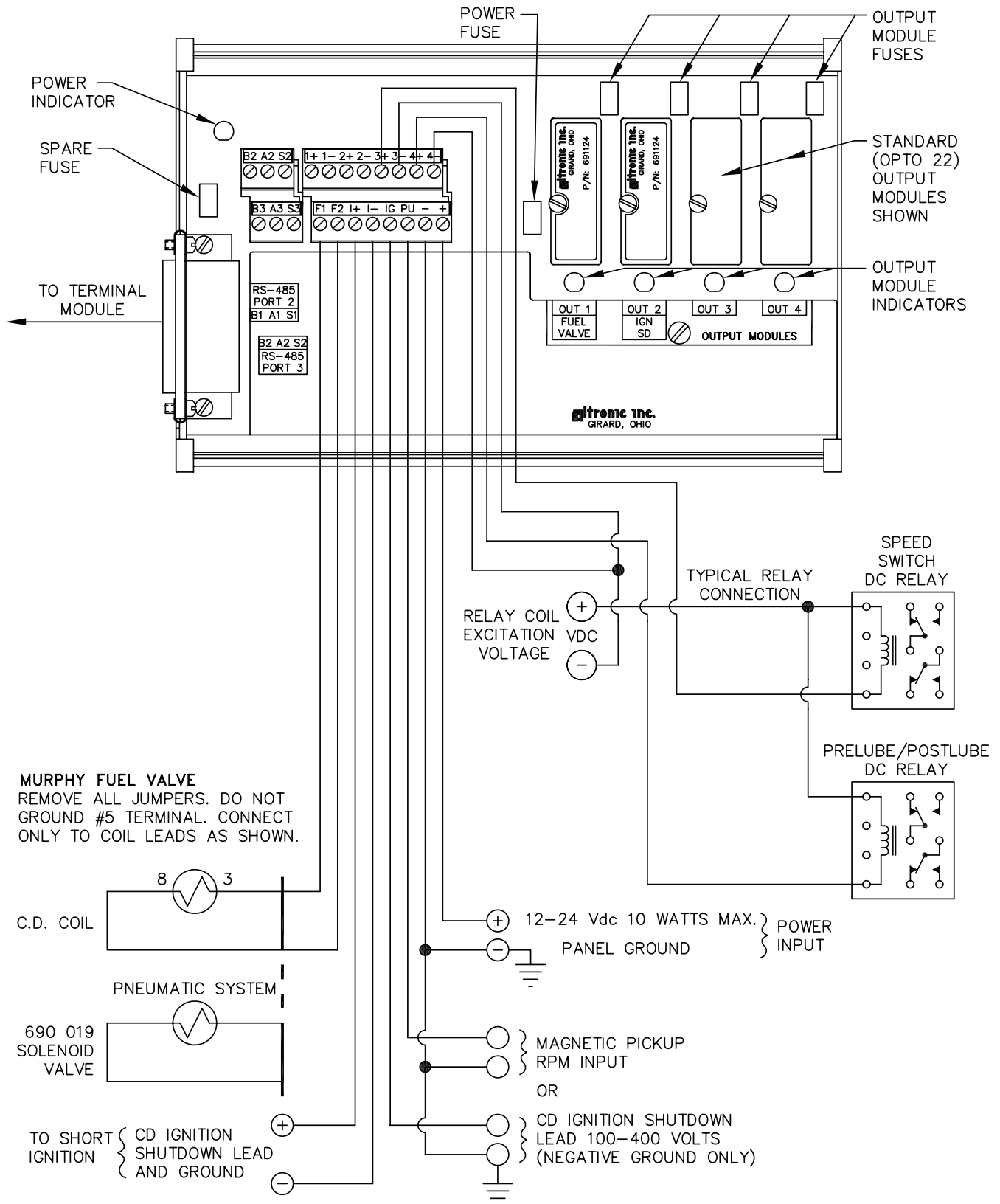
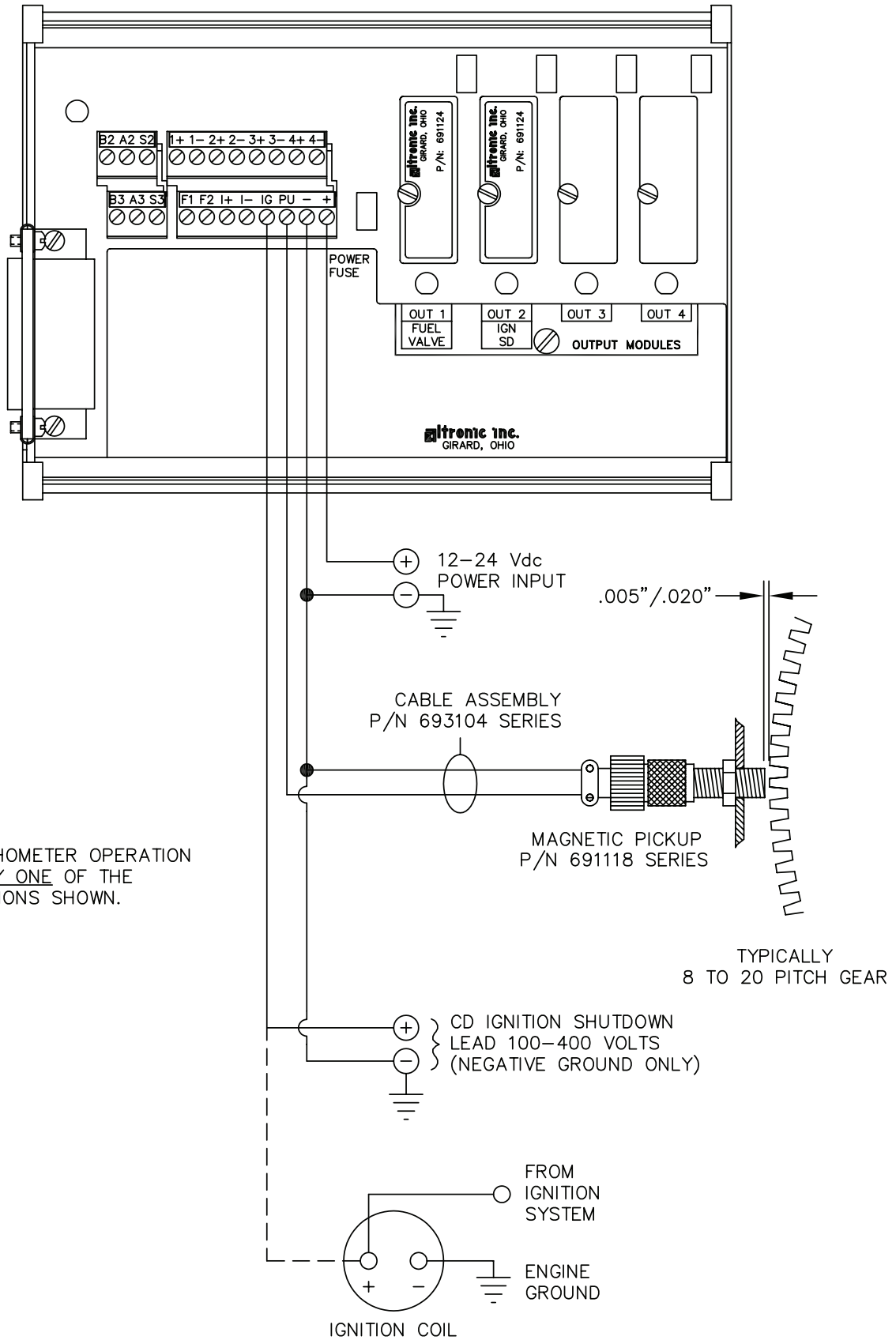

FIG. 11 WIRING DIAGRAM: TACHOMETER INPUT



NOTE:

FOR TACHOMETER OPERATION
USE ONLY ONE OF THE
APPLICATIONS SHOWN.

FIG. 12 WIRING DIAGRAM: RS-485 COMMUNICATIONS

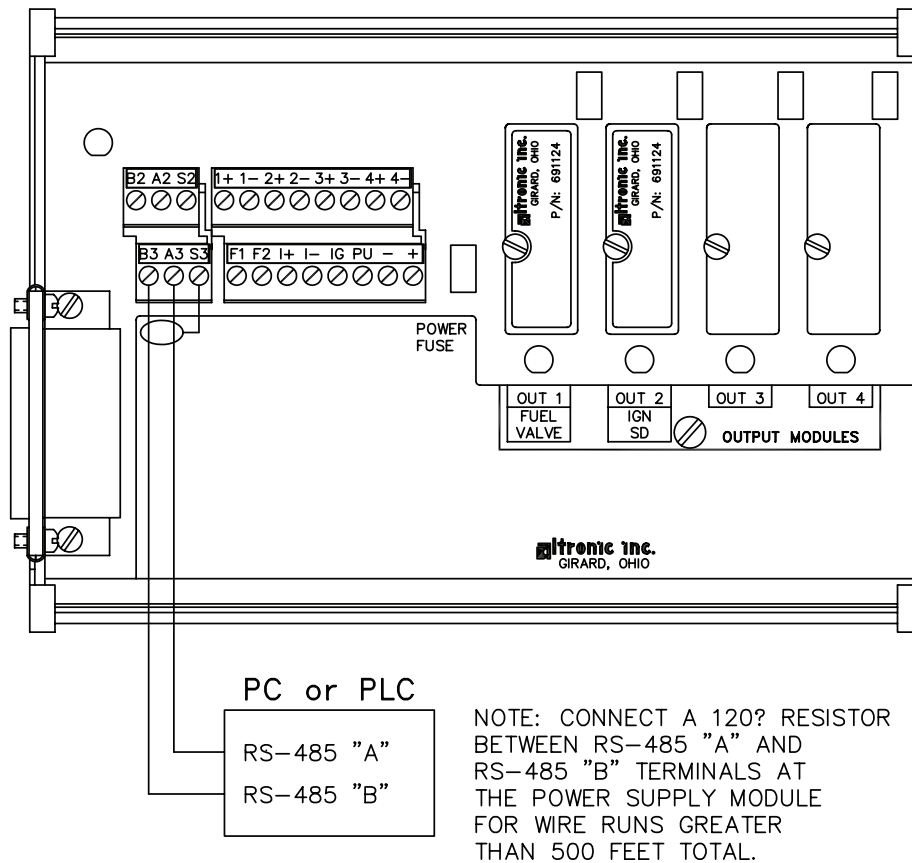

NOTES:

1. USE SHIELDED CABLE FOR RS-485 CONNECTIONS. CONNECT SHIELD AT POWER SUPPLY MODULE ONLY.
2. EACH PLC MUST HAVE A UNIQUE NODE NUMBER. MAXIMUM 32 NODES.
3. TO MINIMIZE UNWANTED REFLECTIONS ON THE RS-485 LINE, THE WIRES SHOULD BE HOOKED-UP FROM ONE INSTRUMENT TO THE NEXT IN A DAISYCHAIN FORMAT.

FIG. 13 DE-3000 DISPLAY – CONTRAST ADJUSTMENT (CLASSIC DISPLAY ONLY)

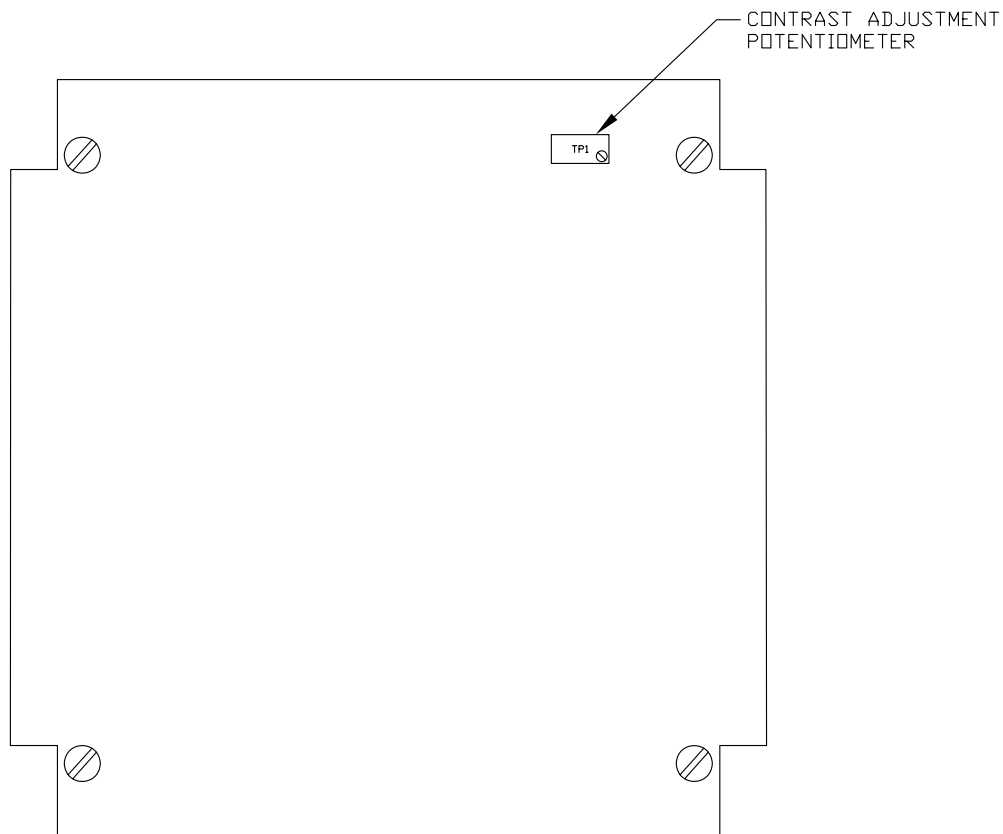

1. TO ADJUST LCD DISPLAY CONTRAST RATIO: USE AN ADJUSTING TOOL AND TURN THE POTENTIOMETER CLOCKWISE TO LIGHTEN THE CONTRAST RATIO OR COUNTERCLOCKWISE TO DARKEN THE CONTRAST RATIO. TO SET THE POTENTIOMETER BACK TO THE FACTORY SETTING; WITH THE DISPLAY MODULE AT AN AMBIENT TEMPERATURE OF APPROXIMATELY 65°F TO 77°F (18°C TO 25°C), TURN THE POTENTIOMETER COUNTERCLOCKWISE THREE TO THREE AND ONE HALF TURNS. THE DISPLAY SHOULD THEN BE AT A DESIRABLE CONTRAST RATIO.

FIG. 14 DRAWING 690 255: INSTALLATION IN DIVISION 1 APPLICATIONS

The DE-3000 system is CSA certified for CLASS I, DIVISION 2, GROUPS C and D areas when mounted in a suitable enclosure.

The DE-3000 system may also be used in a DIVISION 1 hazardous area if it incorporates only the devices shown in the drawing at right, and is installed as shown.

The power connections to the DE-3000 must be in accordance with the National Electrical Code and in Canada, the Canadian Electrical Code.

In addition, the following requirements must be met:

- The low voltage sensor switch wires within the panel enclosure must be kept at least two (2) inches away from other wiring. Run the sensor switch wires leaving the panel in a separate conduit from all other wiring and keep them separate
- Wiring to the sensors must have a grade of insulation capable of withstanding an AC voltage of 500 volts RMS.
- Sensor wires must be run in separate conduits and junction boxes from high voltage wires such as ignition, fuel valve, and other high voltage wiring.

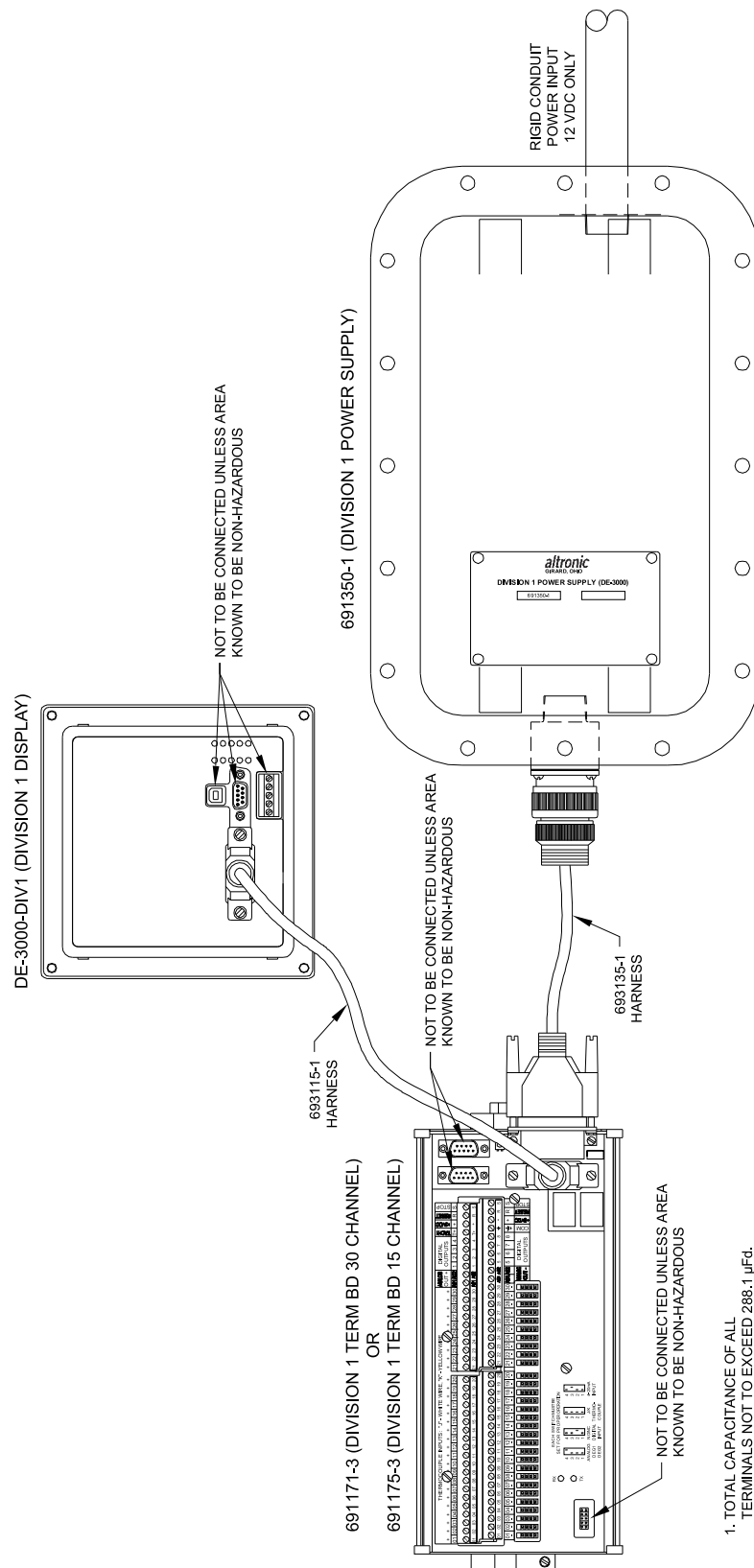

CERTIFIED
CLASS I, DIV.1,
US GROUP D

1. TOTAL CAPACITANCE OF ALL TERMINALS NOT TO EXCEED 288.1 μ Fd.
2. TOTAL INDUCTANCE OF ALL TERMINALS NOT TO EXCEED 8.34 μ H.